

Dell™ Interactive Projector S510

User's Guide



Notes, Cautions, and Warnings



NOTE: A NOTE indicates important information that helps you make better use of your projector



CAUTION: A CAUTION indicates potential damage to hardware or loss of data if instructions are not followed.



WARNING: A WARNING indicates a potential for property damage, personal injury, or death.

**Information in this document is subject to change without notice.
© 2014 Dell Inc. All rights reserved.**

Reproduction of these materials in any manner whatsoever without the written permission of Dell Inc. is strictly forbidden.

Trademarks used in this text: Dell and the DELL logo are trademarks of Dell Inc.; DLP and DLP logo are trademarks of TEXAS INSTRUMENTS INCORPORATED; Microsoft and Windows are either trademarks or registered trademarks of Microsoft Corporation in the United States and/or other countries.

Other trademarks and trade names may be used in this document to refer to either the entities claiming the marks and names or their products. Dell Inc. disclaims any proprietary interest in trademarks and trade names other than its own.

Model: Dell Interactive Projector S510

December 2014 Rev. A00

Contents

1	Your Dell Projector	5
	About Your Interactive Pen	7
2	Connecting Your Projector	9
	Connecting to a Computer	11
	Connecting a DVD Player	19
	Connecting to Local Area Network.	23
3	Using Your Projector	25
	Turning Your Projector On.	25
	Turning Your Projector Off	25
	Adjusting the Projector Focus	26
	Cleaning the Projector's Mirror	26
	Adjusting Projection Image Size	27
	Using the Remote Control.	29
	Installing the Remote Control Batteries	32
	Replacing the Interactive Pen Tips	33
	Replacing the Interactive Pen Batteries	34
	Operating Range with Remote Control	35
	Using the On-Screen Display.	36
	Multimedia Introduction	55
	How to set-up File Type for Multimedia with USB	57
	How to set-up File Type for Multimedia with Internal Memory	59
	Office Viewer for the USB and Internal Memory	61
	Multimedia SETUP for USB and Internal Memory.	62
	Using Intel® Wireless Display (WiDi)	63
	Wireless Display or LAN Display Installation	71
	For Windows Operating System Settings	72
	For Mac Operating System Settings	84
	Audio Projection Installation	89
	USB Display (DoUSB) Installation	101
	IR Pen Interactivity Installation.	104
	Managing the Projector From Web Management	109

	Make Application Token	132
4	Troubleshooting Your Projector	133
	Guiding Signals	138
	Changing the Lamp	139
5	Specifications	141
6	Contacting Dell	147
	Contacting Crestron	148
7	Appendix: Glossary	149

1

Your Dell Projector

Your projector comes with all the items shown below. Ensure that you have all the items, and contact Dell if anything is missing.

Package Contents

Power cable

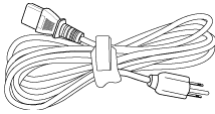

VGA cable (VGA to VGA)

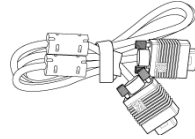

Remote control



AAA Batteries (6)



CD User's Guide and Documentation

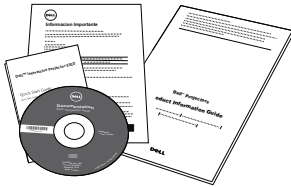

Mini USB cable (USB-A to Mini USB-B)

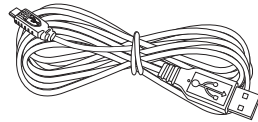

IR Pen (2 pcs)/Pen tip cap (4 pcs)

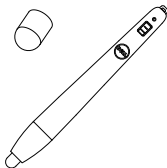

Wrist strap (2 pcs)



About Your Projector

Top View

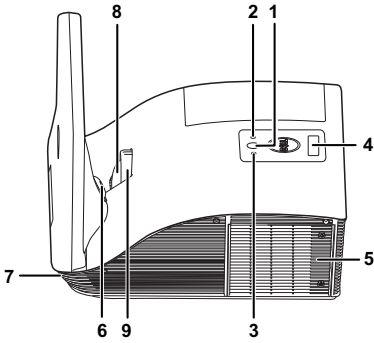

Bottom View

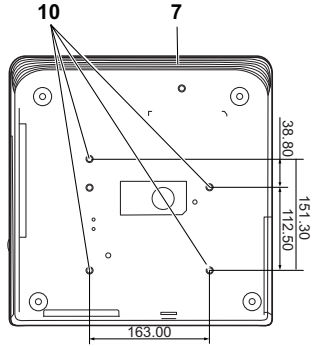

1	Power button
2	Temp LED
3	Lamp LED
4	IR receivers
5	Lamp cover
6	Camera
7	10 W speaker
8	Lens
9	Focus ring
10	Mounting holes for wall mount: Screw hole M4 x 8 mm depth. Recommended torque <10 kgf-cm

About Your Interactive Pen

You can navigate, select, and interact with your computer programs from the projected screen using the interactive pens just as you would a mouse.

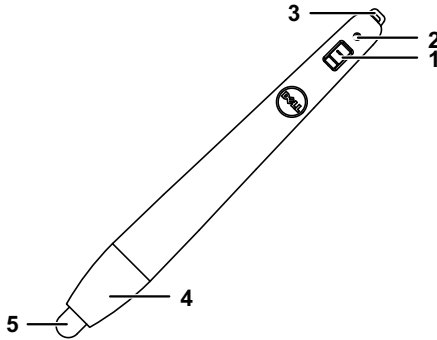

1	Power switch
2	Power indicator As you turn on the pen, the power indicator flashes a few seconds and goes off. Green: Normal operation Red: Battery is low No light: Battery is empty
3	Wrist strap holder
4	Battery compartment access. Turn to open and replace batteries.
5	Pen tip

CAUTION: Safety Instructions

- 1 Do not use the projector near appliances that generate a lot of heat.
- 2 Do not use the projector in areas where there is an excessive amount of dust. The dust may cause the system to fail and the projector will automatically shutdown.
- 3 Ensure that the projector is mounted in a well-ventilated area.
- 4 Do not block the ventilation slots and openings on the projector.
- 5 Ensure the projector operates between ambient temperatures (5 °C to 35 °C).
- 6 Do not try to touch the ventilation outlet as it can become very hot after the projector has been turned on or immediately after it is turned off.
- 7 Do not look into the lens while the projector is on as it may cause injury to your eyes.
- 8 Do not place any objects near or in front of the projector or cover its lens while the projector is on as the heat may cause the object to melt or burn.
- 9 Do not use the wireless projector near cardiac pacemakers.
- 10 Do not use the wireless projector near medical equipment.
- 11 Do not use the wireless projector near microwave ovens.



NOTE:

- Do not attempt to wall mount the projector by yourself. It should be installed by a qualified technician.
- Recommended Projector Wall Mount Kit (P/N: 7XY53). For more information, see the Dell Support website at [dell.com/support](https://www.dell.com/support).
- For more information, see the Safety Information that shipped with your projector.
- The S510 projector can only be used indoors.

2

Connecting Your Projector

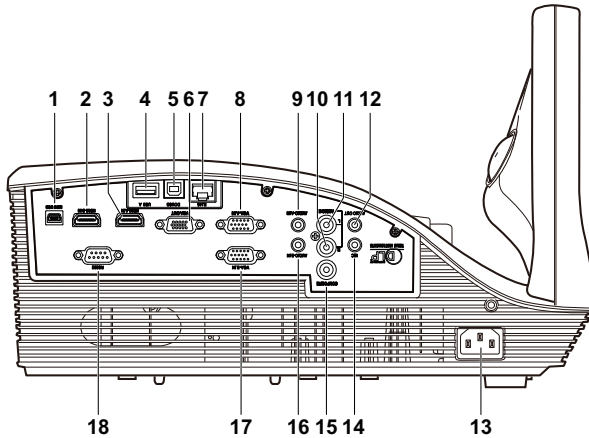

1	Mini USB (Mini Type B) connector for remote control, interactive pen, and firmware upgrade	10	Audio right-channel input connector
2	HDMI-B connector	11	Audio left-channel input connector
3	HDMI-A connector for support MHL feature	12	Audio output connector
4	USB Type A connector for USB Viewer	13	Power cord connector
5	USB Type B connector (DoUSB) for USB Display	14	Microphone connector
6	VGA output (monitor loop through) connector	15	Composite Video connector
7	RJ-45 connector	16	Audio-B input connector
8	VGA-A input (D-sub) connector	17	VGA-B input (D-sub) connector
9	Audio-A input connector	18	RS232 connector

 **CAUTION:** Before you begin any of the procedures in this section, follow the Safety Instructions as described on page 8.

Connecting to a Computer

Connecting a Computer Using a VGA Cable

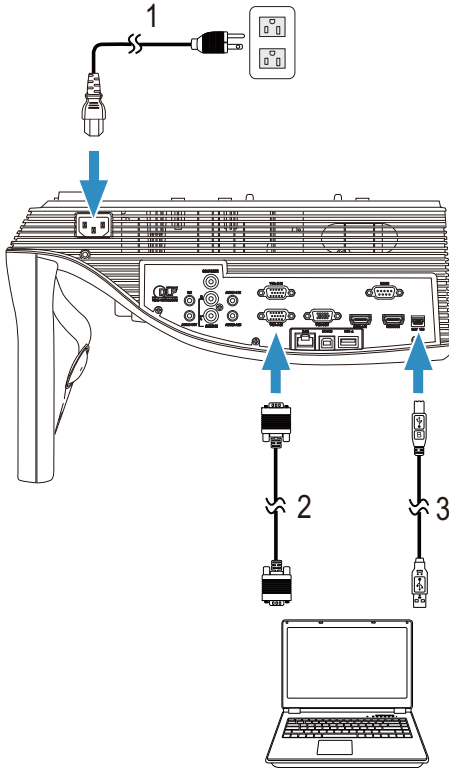

-
- 1 Power cord

 - 2 VGA to VGA cable

 - 3 USB-A to Mini USB-B cable



NOTE: The Mini USB cable must be connected if you want to use the Page Up and Page Down features on the remote control.

Monitor Loop-Through Connection Using VGA Cables

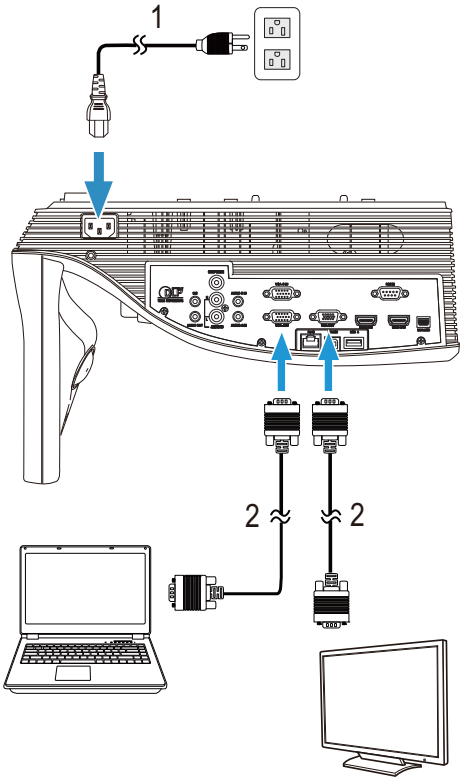

- 1 Power cord
- 2 VGA to VGA cable

NOTE: Only one VGA cable is shipped with your projector. An additional VGA cable can be purchased on the Dell website at www.dell.com.

Connecting a Computer Using a RS232 cable

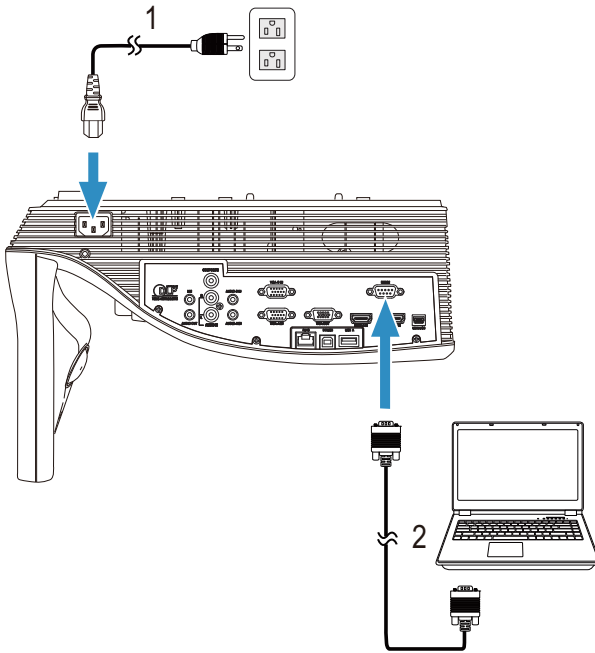

-
- 1 Power cord
 - 2 RS232 (9-pin D-sub female to female pin2-3 swap) cable
-

 **NOTE:** The RS232 (9-pin D-sub female to female pin2-3 swap) cable is not shipped with your projector. Consult a professional installer for the cable and RS232 remote control software.

Connecting a Computer Using a USB Cable

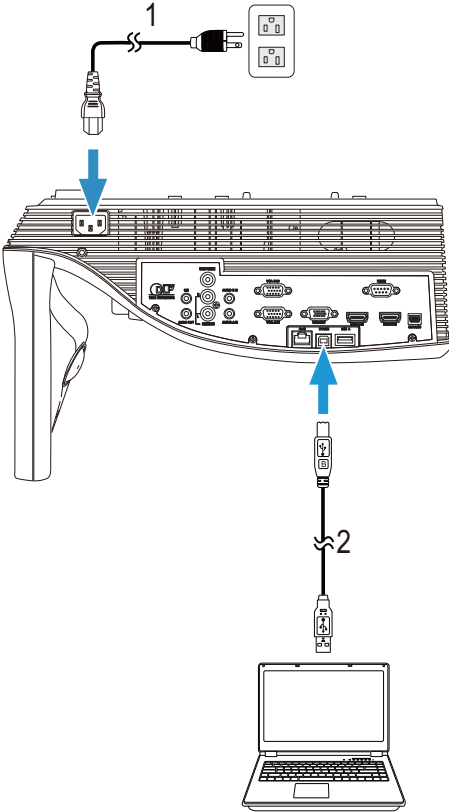

- 1 Power cord
- 2 USB-A to USB-B cable

NOTE: Plug and Play. Only one USB cable is shipped with your projector. An additional USB cable can be purchased on the Dell website at www.dell.com.

Connecting a Computer Using a HDMI Cable

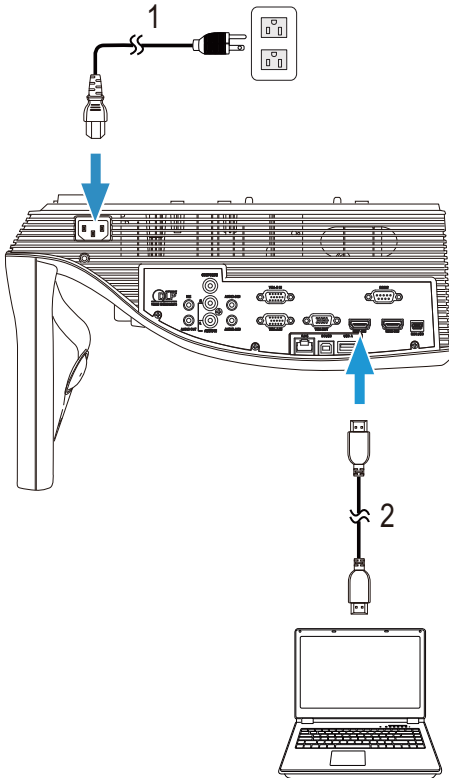

1 Power cord

2 HDMI cable



NOTE: The HDMI cable is not shipped with your projector. You can purchase the HDMI cable on the Dell website at www.dell.com.

Connecting a Mobile Devices (Tablet) Using a MHL Cable

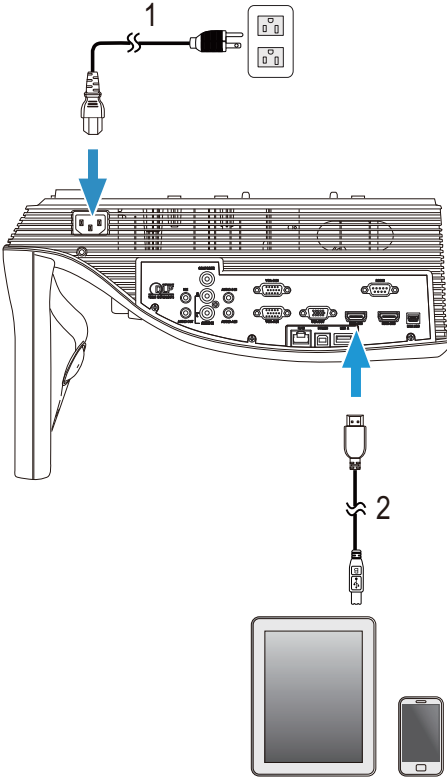

1 Power cord

2 MHL cable

NOTE: The MHL cable is not shipped with your projector.

NOTE:

- a Your smartphone or tablet must support MHL function.
- b Some smartphone or tablet need to connect the additional MHL adapter or adapter cable, please contact your dealer of devices.

Connecting a Computer Using Wireless or Intel® WiDi

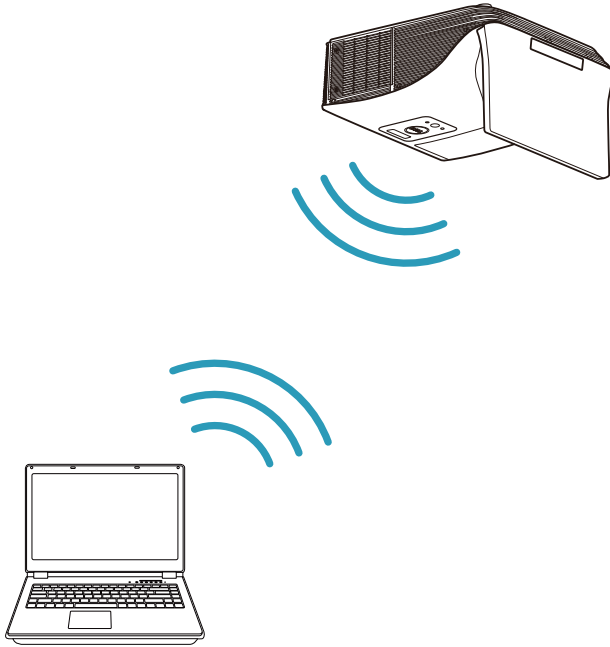

 **NOTE:** Your computer should be equipped with a wireless adapter and properly configured to detect another wireless connection. Refer to your computer's documentation on how to configure a wireless connection.

 **NOTE:** To connect a computer via Intel® WiDi, your computer must be Intel® WiDi compatible.

Connecting to Smartphone or Tablet Using Wireless

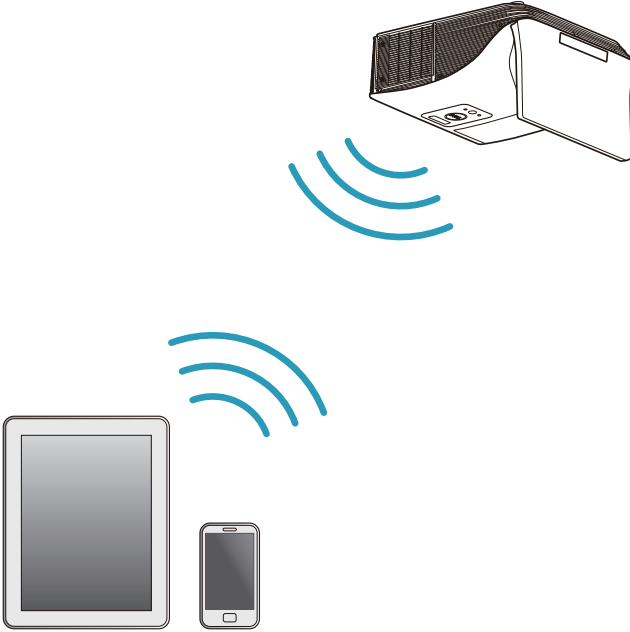

NOTE: Dell S510 supports the MobiShow and WiFi-Doc applications. These applications enable you to transmit supported content from your Android or iOS devices wirelessly. After installing and launching the application on your mobile device, enable Wi-Fi on your mobile device and connect to the projector network, Dell S510. For more Information, please visit go to Dell Support site at dell.com/support. Files supported are:

Mobi Show	Photos	jpeg / jpg
	MS Powerpoint	PtG2 (converted from ppt)*
WiFi-Doc	Photos	jpeg / jpg
	MS Powerpoint / Word / Excel / Text / PDF	ppt / pptx / doc / docx / xls / xlsx / txt / pdf

* Please install the PtG2 Converter into your PC for file conversion of ppt into PtG2 format. PtG2 Converter can be downloaded from dell.com/support.

Connecting a DVD Player

Connecting a DVD Player Using a Composite Video and L/R Audio Cable

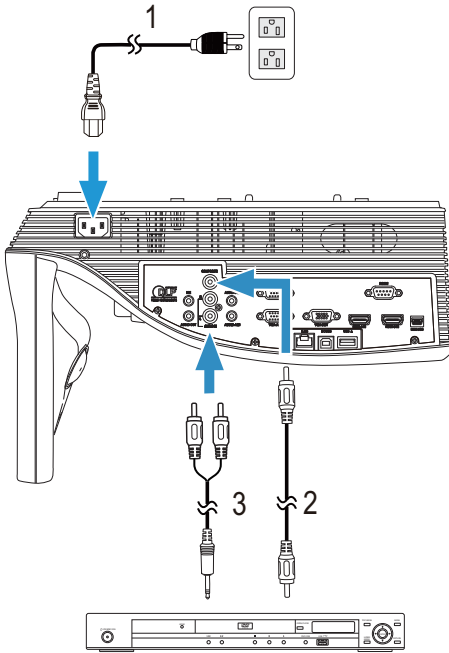

-
- 1 Power cord
 - 2 Composite Video cable
 - 3 L/R audio cable
-

 **NOTE:** The Composite Video cable is not shipped with your projector. You can purchase the Composite Video Extension (50 ft/100 ft) cable on the Dell website at www.dell.com.

 **NOTE:** The L/R audio cable is not shipped with your projector.

Connecting a DVD Player Using a Component Video Cable

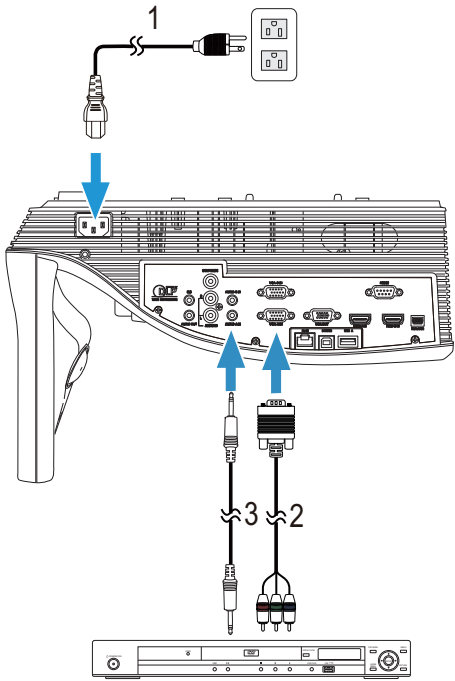

- 1 Power cord
- 2 VGA to Component Video cable
- 3 Audio cable

NOTE: The VGA to Component Video cable and audio cable are not shipped with your projector. You can purchase the VGA to Component Video Extension (50 ft/100 ft) cable on the Dell website at www.dell.com.

Connecting a DVD Player Using a HDMI Cable

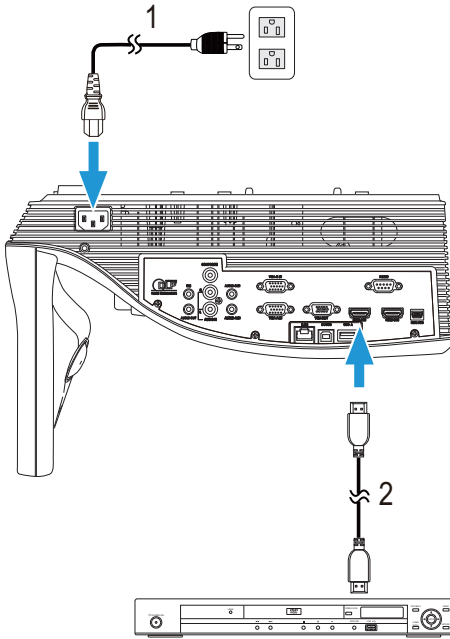

1 Power cord

2 HDMI cable

 **NOTE:** The HDMI cable is not shipped with your projector. You can purchase the HDMI cable on the Dell website at www.dell.com.

Connecting an External Speaker Using Audio Cable

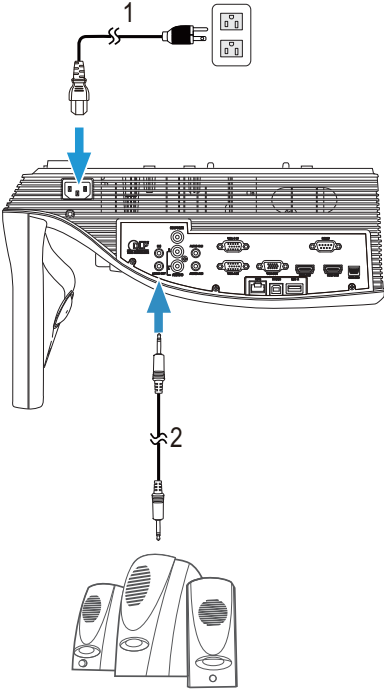

-
- 1 Power cord
 - 2 Audio cable
-

 **NOTE:** The audio cable is not shipped with your projector.

Connecting to Local Area Network

To project an image and control the projector that is connected to a network through a RJ45 cable.

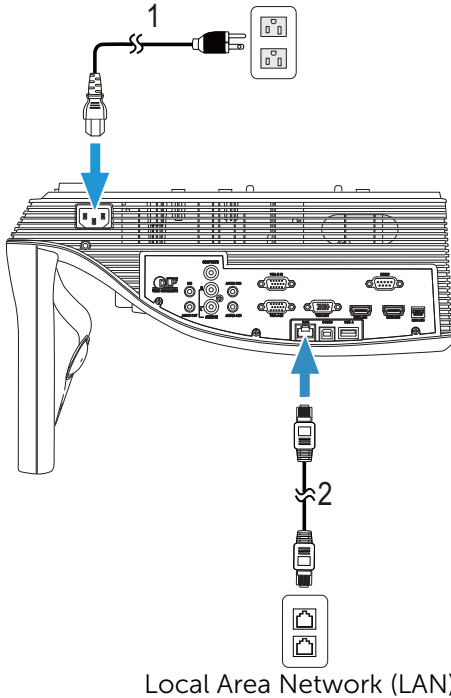

1 Power cord

2 RJ45 cable



NOTE: The RJ45 cable is not shipped with your projector. You can purchase the RJ45 cable on the Dell website at www.dell.com.

Connection With Commercial RS232 Control Box

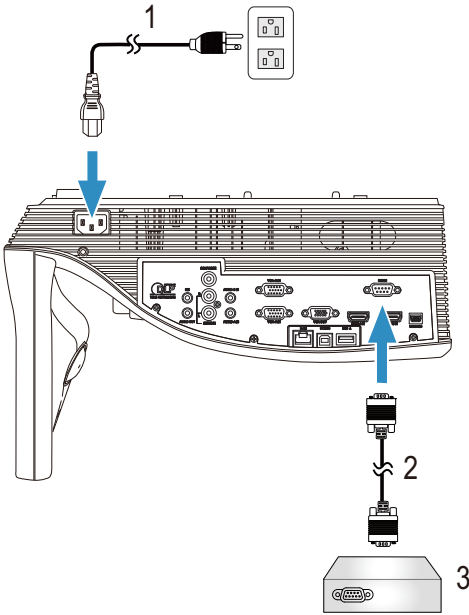

-
- 1 Power cord

 - 2 RS232 (9-pin D-sub female to female pin2-3 swap) cable

 - 3 Commercial RS232 control box

 **NOTE:** The RS232 (9-pin D-sub female to female pin2-3 swap) cable is not shipped with your projector. Consult a professional technician to obtain the cable.

3

Using Your Projector

Turning Your Projector On



NOTE: Turn on the projector before you turn on the source (computer, DVD player, etc.). The **Power** button light blinks white until pressed.

- 1 Connect the power cord and appropriate signal cables to the projector. For information about connecting the projector, see "Connecting Your Projector" on page 9.
- 2 Press the **Power** button (see "Using the Remote Control" on page 29 to locate the **Power** button).
- 3 Turn on your source (computer, DVD player, etc.)
- 4 Connect your source to the projector using the appropriate cable. See "Connecting Your Projector" on page 9 for instructions to connect your source to the projector.
- 5 By default, the input source of the projector is set to VGA-A. Change the input source of the projector if necessary.
- 6 If you have multiple sources connected to the projector, press the **Source** button on the remote control to select the desired source. See "Using the Remote Control" on page 29 to locate the **Source** button.

Turning Your Projector Off



CAUTION: Unplug the projector after properly shutting down as explained in the following procedure.

- 1 Press the **Power** button. Follow the instruction displayed on screen to properly turn off the projector.



NOTE: The "**Press Power Button to Turn off Projector**" message will appear on the screen. The message disappears after 5 seconds or you can press the **Menu** button to clear it.

- 2 Press the **Power** button again. The cooling fans continue to operate for 120 seconds.
- 3 To power off the projector quickly, press the **Power** button and hold for 1 second while the projector's cooling fans are still running.



NOTE: Before you turn on the projector again, wait for 60 seconds to allow the internal temperature to stabilize.

4 Disconnect the power cord from the electrical outlet and the projector.

Adjusting the Projector Focus

1 Rotate the focus ring until the image is clear. The projector focuses at distances ranging between 1.7 ft to 2.49 ft (0.517 m to 0.759 m \pm 0.01 m).

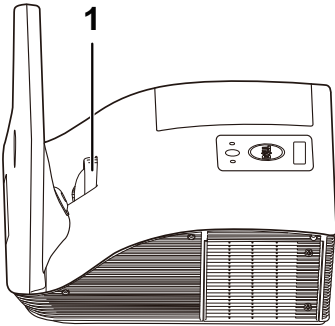

1	Focus ring
---	------------

Cleaning the Projector's Mirror

- 1 Turn off the projector power and disconnect the power cord.
- 2 Let the projector cool for at least 30 minutes.
- 3 Use air blower bulb to blow off dust on the mirror or gently wipe the mirror by using a microfiber cleaning cloth. Do not scrub the surface of the mirror. It may scratch the mirror.



CAUTION: Do not spray cleaners or solvents directly on the projector.



WARNING: Cleaning a wall-mounted projector can result in a fall or injury. You can remove the projector from the wall-mounting bracket to clean the projector's mirror.

Adjusting Projection Image Size

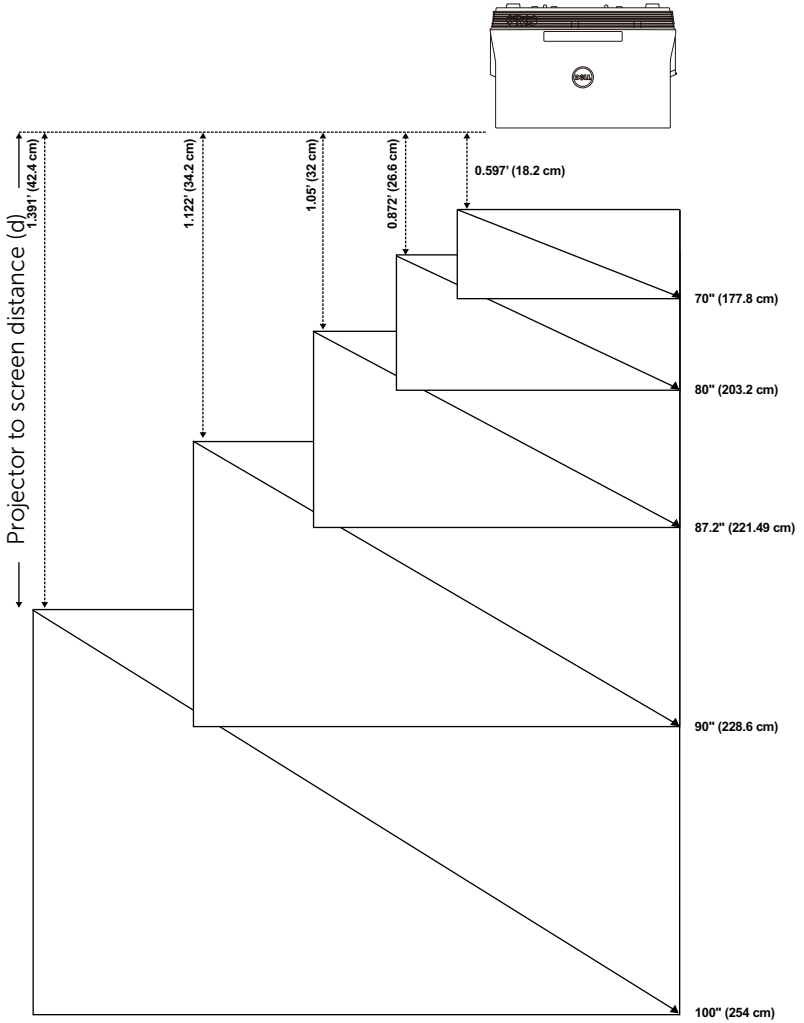

Projection Distance (cm) [A]	Projection Distance (cm) [B]	Image size			Projector base to top of image (cm) [D]	Projector base to bottom of image (cm) [E]
		Diagonal (inch/cm) [C]	Width (cm)	Height (cm) [H]		
51.7	18.2	70"/177.8 cm	148	92	120	28
60.1	26.6	80"/203.2 cm	172	107	139	32
65.5	32	87.2"/221.4 cm	187	117	151	34
67.7	34.2	90"/228.6 cm	193	121	156	35
75.9	42.4	100"/254 cm	217	136	175	39

* This graph is for user reference only.

* Offset Ratio: 125±5%



NOTE: The distance from mirror to the rear of projector: 33.5 cm

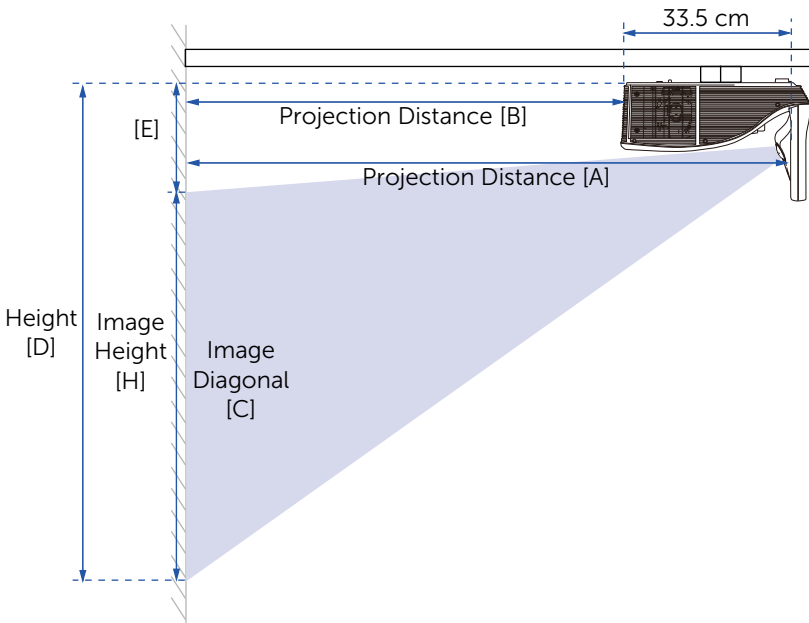

Using the Remote Control

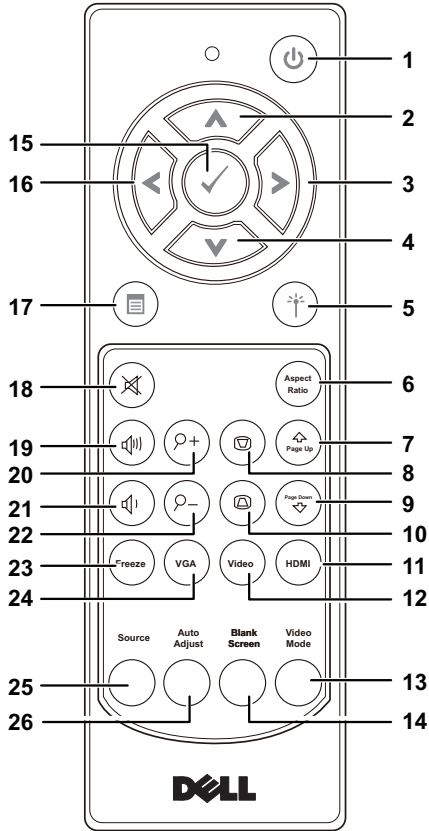

1 Power 

Turns the projector on or off. For more information, see "Turning Your Projector On" on page 25 and "Turning Your Projector Off" on page 25.

2 Up 













Press to navigate through the On-Screen Display (OSD) Menu items.









3 Right 

Press to navigate through the On-Screen Display (OSD) Menu items.

4 Down 

Press to navigate through the On-Screen Display (OSD) Menu items.

5	Laser 	Point the remote control at the screen, press and hold the laser button to activate the laser light.  CAUTION: Do not look at the laser point when it is active. Avoid directing the laser light on your eyes.
6	Aspect Ratio 	Press to change the aspect ratio of a displayed image.
7	Page up 	Press to move to the previous page.  NOTE: The Mini USB cable must be connected if you want to use the Page Up feature.
8	Keystone adjustment + 	Press to adjust image distortion caused by tilting the projector (-15/+15 degrees).
9	Page down 	Press to move to the next page.  NOTE: The Mini USB cable must be connected if you want to use the Page Down feature.
10	Keystone adjustment - 	Press to adjust image distortion caused by tilting the projector (-15/+15 degrees).
11	HDMI 	Press to choose HDMI source.
12	Video 	Press to choose Composite Video source.
13	Video mode	The projector has preset configurations that are optimized for displaying data (presentation slides) or video (movies, games, etc.). Press the Video Mode button to toggle between Presentation mode, Bright mode, Movie mode, sRGB, or Custom mode. Pressing the Video Mode button once will show the current display mode. Pressing the Video Mode button again will switch between modes.
14	Blank screen	Press to hide/unhide the image.
15	Enter 	Press to confirm the selection.

16	Left 	Press to navigate through the On-Screen Display (OSD) Menu items.
17	Menu 	Press to activate the OSD.
18	Mute 	Press to mute or un-mute the projector speaker.
19	Volume up 	Press to increase the volume.
20	Zoom + 	Press to increase the image.
21	Volume down 	Press to decrease the volume.
22	Zoom - 	Press to decrease the image.
23	Freeze 	Press to pause the screen image, then press "Freeze" again to unfreeze the image.
24	VGA 	Press to choose VGA source.
25	Source	Press to switch between VGA-A, VGA-B, Composite, HDMI-A, HDMI-B, Wireless Display, USB Display, USB Viewer, Intel® WiDi, and Internal Memory source.
26	Auto Adjust	Press to synchronize the projector with the input source. Auto adjust does not operate if the OSD is displayed.

Installing the Remote Control Batteries



NOTE: Remove the batteries from the remote control when not in use.

1 Press the tab to lift the battery compartment cover.

1

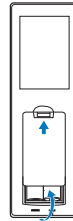

2 Check the polarity (+/-) marking on the batteries.

2

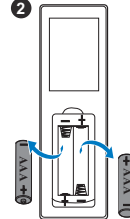

3 Insert the batteries and align their polarity correctly according to the marking in the battery compartment.

3

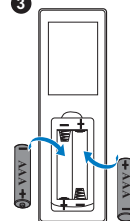

4 Slip the battery cover back.

4

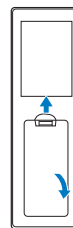

Replacing the Interactive Pen Tips



NOTE: If the pen tip becomes damaged or no longer works well, you should replace them.

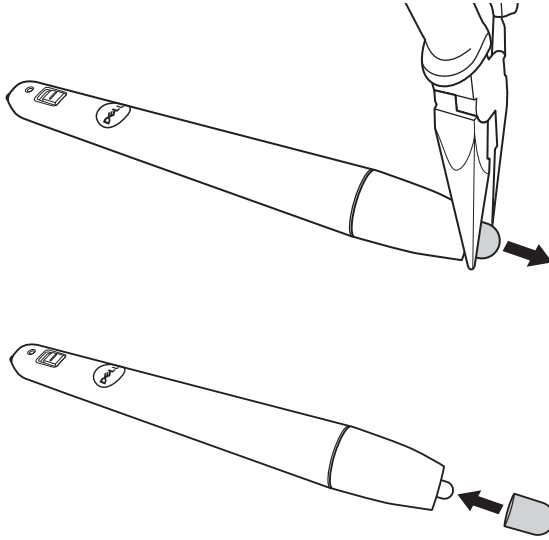

Replacing the Interactive Pen Batteries

 **NOTE:** If the battery is low, the LED indicator starts flashing red as you turn on the pen. You should replace with two new AAA batteries.

1 You can access the battery compartment by turning open the pen head.

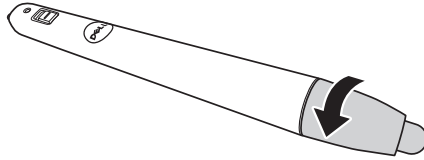

2 Check the polarity (+/-) marking on the batteries.

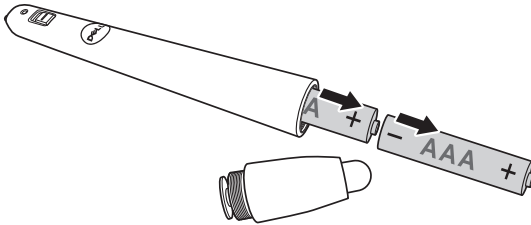

3 Insert the batteries and align their polarity correctly according to the marking on the pen head.

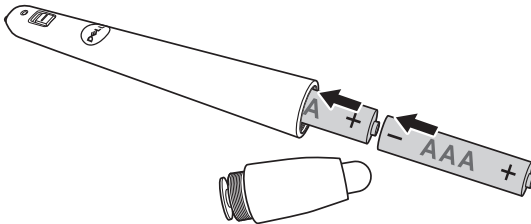

 **NOTE:** Avoid mixing different types of batteries or using new and old batteries together.

4 Place the pen head back, turn until the battery compartment access fully closed.

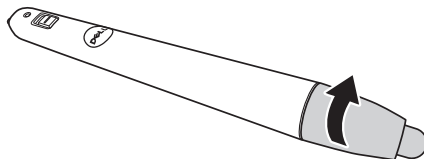





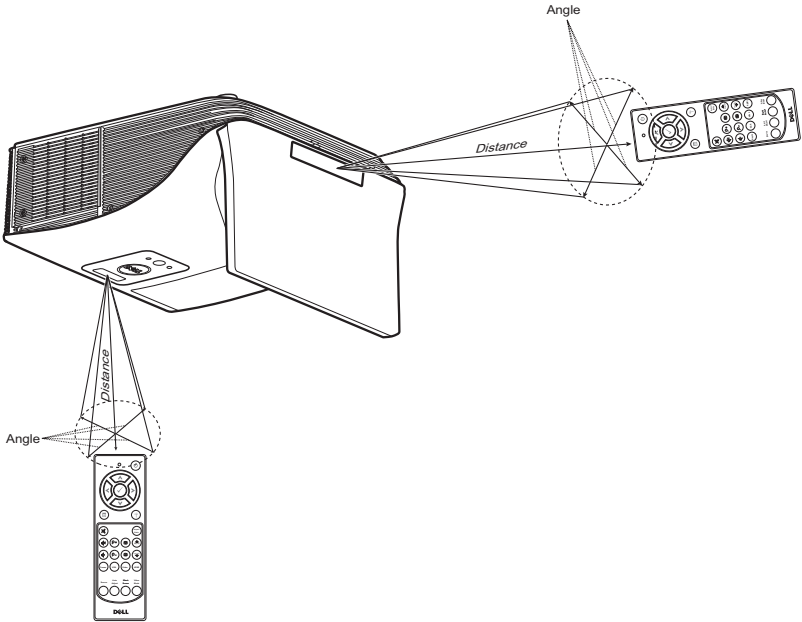



Operating Range with Remote Control

Operating range	
Angle	$\pm 40^\circ$
Distance	7 m/22.97 feet



NOTE: Actual operating range may slightly differ from the diagram. Weak batteries will also prevent the remote control from properly operating the projector.

Using the On-Screen Display

- The projector has a multi-language On-Screen Display (OSD) Menu that can be displayed with or without an input source.
- Press the Menu button on the remote control to enter the Main Menu.
- To navigate through the tabs in the Main Menu, press the  or  buttons on the remote control.
- To select a submenu, press the  or  button on the remote control.
- To select an option, press the  or  buttons on the remote control. When an item is selected, the color changes to dark blue.
- Use the  or  buttons on the remote control to adjust the settings.
- To go back to the Main Menu, press the  button on the remote control.
- To exit the OSD, press the Menu button directly on the remote control.

INPUT SOURCE

The Input Source menu allows you to select your projector's input source.

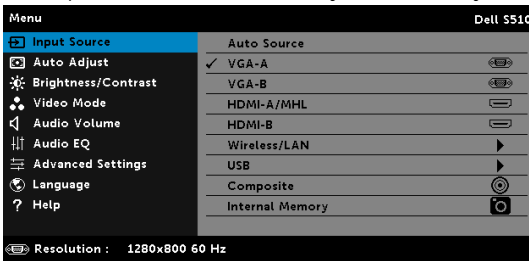

VGA-A—Press  to detect a VGA-A signal.

VGA-B—Press  to detect a VGA-B signal.

HDMI-A/MHL—Press  to detect a HDMI-A/MHL signal.

HDMI-B—Press  to detect a HDMI-B signal.

WIRELESS/LAN—Press  to activate the Input Source WIRELESS/LAN menu.



NOTE: The WIRELESS/LAN can be used after the "Wireless and LAN" option is turned on.

USB—Press  to activate the Input Source USB menu.



NOTE: The USB can be used after the "Wireless and LAN" option is turned on.

COMPOSITE—Press  to detect a Composite Video signal.

INTERNAL MEMORY—Allows you to playback the photo, video, music, and MS word, excel, powerpoint, and PDF files from internal memory of the projector.

 **NOTE:**

STORAGE MODE—You may also connect USB cable in Internal Memory source to execute copy, delete, move and more instructions from your computer to projector internal memory.

When you connect the projector and computer via USB cable, a USB Connected message will pop up and allow you to select **DoUSB** or **Storage Mode**.

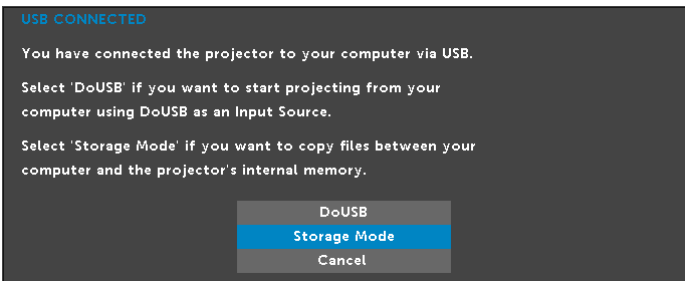

INPUT SOURCE WIRELESS/LAN

The Input Source Wireless/LAN menu allows you to activate the Intel® WIDI/Miracast and Wireless/LAN Display.

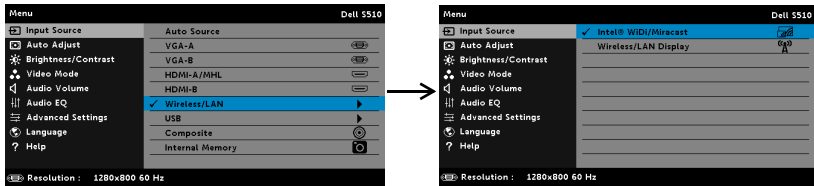

INTEL® WIDI/MIRACAST—Press to access the projector's Intel® WIDI or Miracast Guide screen.

WIRELESS/LAN DISPLAY—Press to access the projector's Wireless or LAN Guide screen. See "Wireless/LAN Guide screen" on page 73.

INPUT SOURCE USB

The Input Source USB menu allows you to activate the USB Display and USB Viewer.

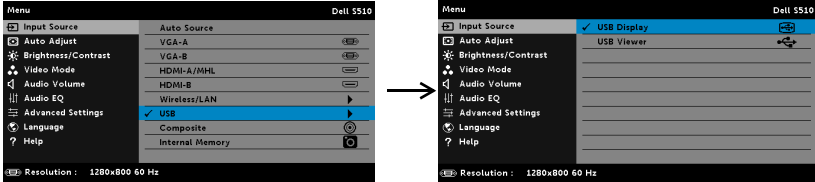

USB DISPLAY—Allows you to display the computer/laptop screen to your projector via the USB cable.



NOTE: If the DoUSB can't display, please see "Troubleshooting Your Projector" on page 133.

USB VIEWER—Allows you to playback the photo, video, music, and MS word, excel, powerpoint, and PDF files from your USB flash disk.

AUTO ADJUST

Auto Adjust automatically adjusts the projector's Horizontal, Vertical, Frequency, and Tracking in PC mode.

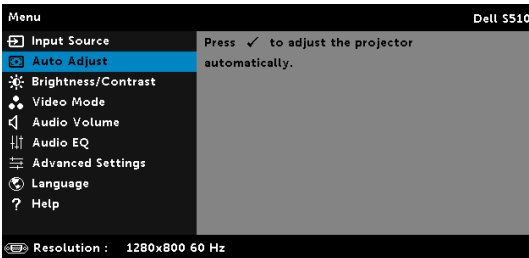

BRIGHTNESS/CONTRAST

The Brightness/Contrast menu allows you adjust the brightness/contrast settings of your projector.



BRIGHTNESS—Use and to adjust the brightness of the image.

CONTRAST—Use and to adjust the display contrast.



NOTE: If you adjust the settings for **Brightness** and **Contrast** the projector automatically switches to Custom mode.

VIDEO MODE

The Video Mode menu allows you to optimize the display image: **Presentation**, **Bright**, **Movie**, **sRGB** (provides more accurate color representation), and **Custom** (set your preferred settings).

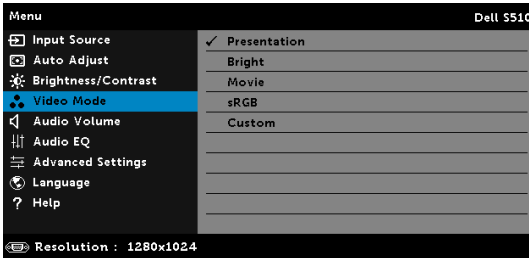

AUDIO VOLUME

The Audio Volume menu allows you adjust the **Audio**, **Microphone**, **Master** volume settings of your projector.

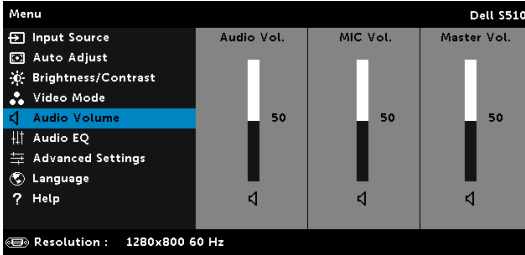

AUDIO VOLUME—Press to increase the audio volume and to decrease the audio volume.

MIC VOLUME—Press to increase the microphone volume and to decrease the microphone volume.

Master Volume—Press to increase the audio and microphone volume and decrease the audio and microphone volume.

AUDIO EQ

The Audio EQ menu allows you adjust the audio to boost or reduce (attenuating) the levels of different frequencies in a signal.

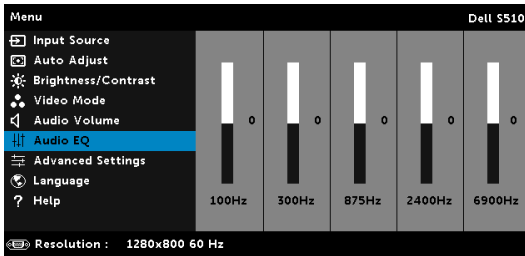

ADVANCED SETTINGS

The Advanced Settings menu allows you to change settings for **Image**, **Display**, **Projector**, **LAN**, **Wireless**, **Menu**, **Power**, and **Information**.

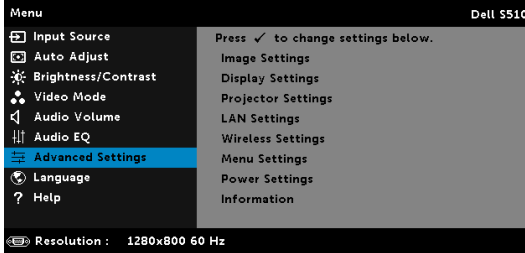
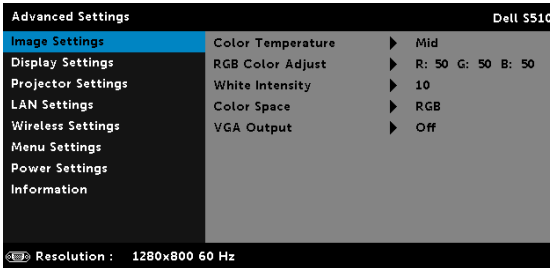

IMAGE SETTINGS (IN PC MODE)—Select and press to activate image settings. The image settings menu provides the following options:



COLOR TEMPERATURE—Allows you to adjust the color temperature. The screen appears cooler at higher color temperatures and warmer at lower color temperatures. When you adjust the values in the **Color Adjust** menu, the Custom mode is activated. The values are saved in the Custom mode.

RGB COLOR ADJUST—Allows you to manually adjust the colors red, green, and blue.

WHITE INTENSITY—Press and use and to display white intensity.

COLOR SPACE—Allows you to select the color space. The options are: RGB, YCbCr, and YPbPr.

VGA OUTPUT—Select On or Off the VGA output function at projector standby status. Default is Off.



NOTE: If you adjust the settings for **Color Temperature**, **RGB Color Adjust**, and **White Intensity** the projector automatically switches to **Custom mode**.

IMAGE SETTINGS (IN VIDEO MODE)—Select and press to activate image settings. The image settings menu provides the following options:

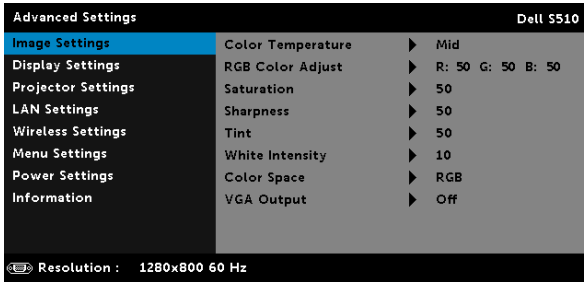

COLOR TEMPERATURE—Allows you to adjust the color temperature. The screen appears cooler at higher color temperatures and warmer at lower color temperatures. When you adjust the values in the **Color Adjust** menu, the Custom mode is activated. The values are saved in the Custom mode.

RGB COLOR ADJUST—Allows you to manually adjust the colors red, green, and blue.

SATURATION—Allows you to adjust the video source from black and white to fully saturated color. Press to increase the amount of color in the image and to decrease the amount of color in the image.

SHARPNESS—Press to increase the sharpness and to decrease the sharpness.

TINT—Press to increase the amount of green in the image and to decrease the amount of green in the image.

WHITE INTENSITY—Press and use and to display white intensity.

COLOR SPACE—Allows you to select the color space. The options are: RGB, YCbCr, and YPbPr.

VGA OUTPUT—Select On or Off the VGA output function at projector standby status. Default is Off.



NOTE:

- 1 If you adjust the settings for **Color Temperature**, **RGB Color Adjust**, **Saturation**, **Sharpness**, **Tint**, and **White Intensity** the projector automatically switches to Custom mode.

2 Saturation, Sharpness, and Tint only available when the input source is from Composite.

IMAGE SETTINGS (NO INPUT SOURCE)—Select and press to activate image settings. The image settings menu provides the following options:

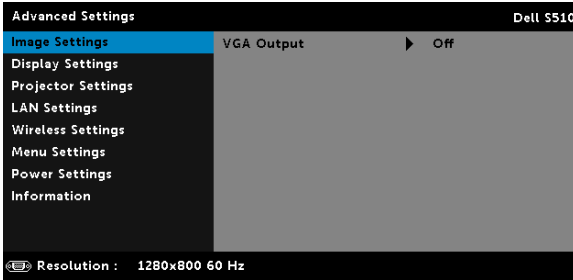

VGA OUTPUT—Select On or Off the VGA output function at projector standby status. Default is Off.

DISPLAY SETTINGS (IN PC MODE)—Select and press to activate display settings. The display settings menu provides the following options:

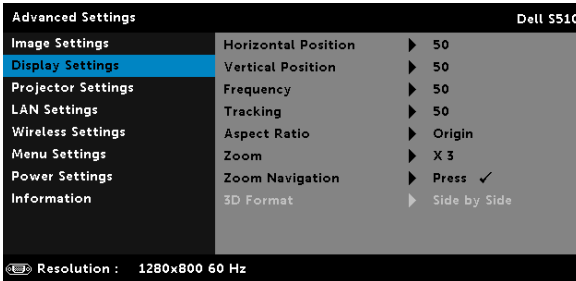

HORIZONTAL POSITION—Press to move the image right and to move the image left.



VERTICAL POSITION—Press to move the image up and to move the image down.

FREQUENCY—Allows you to change the display data clock frequency to match the frequency of your computer's graphics card. If you see a vertical flickering wave, use the Frequency control to minimize the bars. This is a coarse adjustment.



TRACKING—Synchronize the phase of the display signal with the graphic card. If you experience an unstable or flickering image, use Tracking to correct it. This is a fine adjustment.

ASPECT RATIO—Allows you to select the aspect ratio to adjust how the image appears. Options are: Origin, 16:10, and 4:3.

- Origin — Select Origin to maintain the aspect ratio of the image projector according to the input source.
- 16:10 — The input source scales to fit the width of the screen to project a 16:10 screen image.
- 4:3 — The input source scales to fit the screen and projects a 4:3 image.

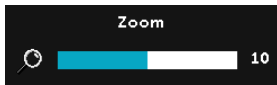



ZOOM—Press  and  to zoom and view the image.

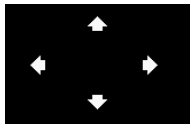

Adjust the image scale by pressing  or  and press  to view on your remote control only.



ZOOM NAVIGATION—Press  to activate the **Zoom Navigation** menu.

Use     to navigate the projection screen.

3D FORMAT—Allows you to select the 3D format. Options are: Side By Side, Side By Side Full, Top/Bottom, and Top/Bottom Full.

3D SYNC INVERT—If you see a discrete or overlapping image while wearing DLP 3D goggles, you may need to execute 'Invert' to get best match of left/right image sequence to get the correct image. (For DLP 3D goggles)

 **NOTE:**

- 1 When you want to create a 3D experience, you will need a few other components including:
 - a "Active" 3D glasses with DLP Link™.
 - b 3D content. See "Note 2".
 - c 3D Player.
- 2 HDMI 1.4a 3D support and refresh rate are as below:
 - a 1280x720p@50 Hz Frame Packing
 - b 1280x720p@59.94/60 Hz Frame Packing
 - c 1920x1080p@23.98/24 Hz Frame Packing
 - d 1920x1080i@50 Hz Side by Side Half
 - e 1920x1080i@59.94/60 Hz Side by Side Half
 - f 1280x720p@50 Hz Top and Bottom

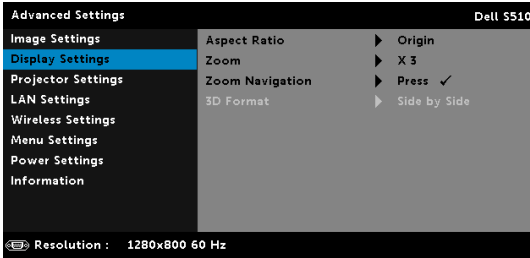

- g 1280x720p@59.94/60 Hz Top and Bottom
- h 1920x1080p@23.98/24 Hz Top and Bottom

DISPLAY SETTINGS (IN VIDEO MODE)—Select and press  to activate display settings. The display settings menu provides the following options:





ASPECT RATIO—Allows you to select the aspect ratio to adjust how the image appears. Options are: Origin, 16:10, and 4:3.

- Origin — Select Origin to maintain the aspect ratio of image projector according to the input source.
- 16:10 — The input source scales to fit the width of the screen to project a 16:10 screen image.
- 4:3 — The input source scales to fit the screen and projects a 4:3 image.

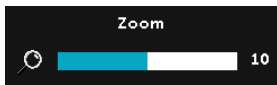



ZOOM—Press  and  to zoom and view the image.

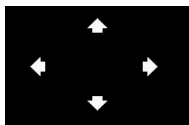

Adjust the image scale by pressing  or  and press  to view on your remote control only.



ZOOM NAVIGATION—Press  to activate the Zoom Navigation menu.

Use     to navigate the projection screen.

3D FORMAT—Allows you to select the 3D format. Options are: Side By Side, Side By Side Full, Top/Bottom, and Top/Bottom Full.

3D SYNC INVERT—If you see a discrete or overlapping image while wearing DLP 3D goggles, you may need to execute 'Invert' to get best match of left/right image sequence to get the correct image. (For DLP 3D goggles)

 **NOTE:**

- 1 When you want to create a 3D experience, you will need a few other components including:
 - a "Active" 3D glasses with DLP Link™.
 - b 3D content. See "Note 2".
 - c 3D Player.
- 2 HDMI 1.4a 3D support and refresh rate are as below:
 - a 1280x720p@50 Hz Frame Packing
 - b 1280x720p@59.94/60 Hz Frame Packing
 - c 1920x1080p@23.98/24 Hz Frame Packing
 - d 1920x1080i@50 Hz Side by Side Half
 - e 1920x1080i@59.94/60 Hz Side by Side Half
 - f 1280x720p@50 Hz Top and Bottom
 - g 1280x720p@59.94/60 Hz Top and Bottom
 - h 1920x1080p@23.98/24 Hz Top and Bottom

PROJECTOR SETTINGS—Select and press  to activate projector settings. The projector settings menu provides the following options:

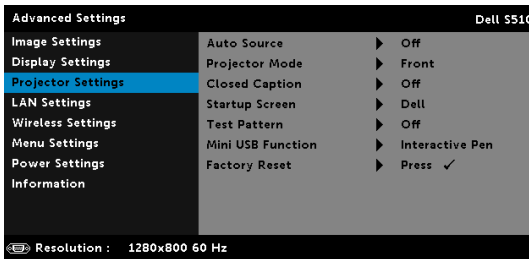

AUTO SOURCE—Select Off (the default) to lock the current input signal. If you press the Source button when the Auto Source mode is set to Off, you can manually select the input signal. Select On to auto detect the available input signals. If you press the Source button when the projector is on, it automatically finds the next available input signal.

PROJECTOR MODE—Allows you to select the projector mode, depending upon how the projector is mounted.

- Rear Projection-Wall Mount — The projector reverses and turns the image upside down. You can project from behind a translucent screen with a wall-mounted projection (for regular projection).
- Front Projection-Wall Mount — The projector turns the image upside down for wall-mounted projection.

CLOSED CAPTION—Select **On** to enable close caption and activate the closed caption menu. Select appropriate closed caption options: CC1, CC2, CC3, and CC4.

 **NOTE:**

- 1 Closed caption option is available for NTSC only.
- 2 Closed captioning can only be enabled via Composite Video input.

STARTUP SCREEN—Default is Dell logo as wallpaper. You can also select Capture Screen option to capture the screen display. The following message appears on the screen.

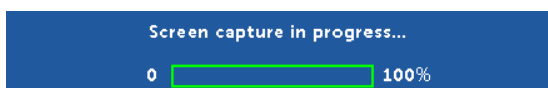

 **NOTE:** To capture a full image, ensure that the input signal connected to the projector is at 1280 x 800 resolution.

TEST PATTERN—Test Pattern is used to test focus and resolution.

You can enable or disable the **Test Pattern** by selecting **Off**, **1**, or **2**.

Test Pattern 1:

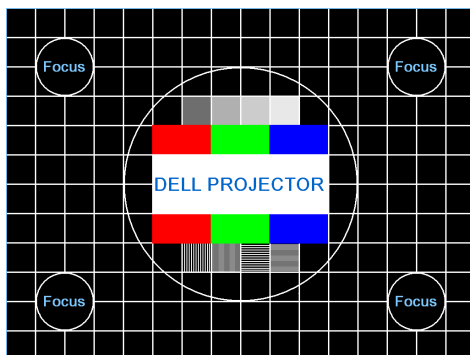

Test Pattern 2:

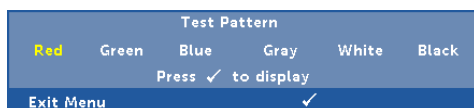

MINI USB FUNCTION—Allows you to select the **Interactive Pen** or **Remote Pg Ctrl**.

FACTORY RESET—Select Confirm and press  to reset all settings to its factory default. The below warning message appears:





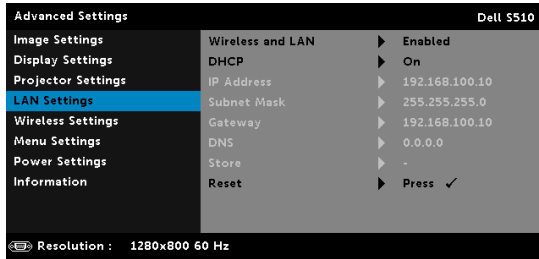

Reset items include both computer sources and Video source settings.

LAN SETTINGS—Select and press  to activate LAN settings. The LAN settings menu provides the following options:



WIRELESS AND LAN—Select **Enabled** to activate the Wireless and LAN function. Select **Disabled** to deactivate the Wireless and LAN function.

DHCP—If a DHCP server exists in the network to which the projector is connected, the IP address will automatically be acquired when you select DHCP On. If DHCP is Off, manually set the IP Address, Subnet Mask, and Gateway. Use  and  to select the number of IP address, Subnet Mask, and Gateway. Key in enter to confirm each number and then use  and  to set the next item.

IP ADDRESS—Automatically or manually assigns the IP address to the projector connected to the network.

SUBNET MASK—Configure the Subnet Mask of the network connection.

GATEWAY—Check the Gateway address with your network/system administrator if you configure it manually.

DNS—Check the DNS Server IP address with your network/system administrator if you configure it manually.

STORE—Press  to save the changes made in network configuration settings.

 **NOTE:**

- 1 Use and button to select IP Address, Subnet Mask, Gateway, DNS, and Store.
- 2 Press the button to enter IP Address, Subnet Mask, Gateway or DNS to set the value. (The selected option is highlighted in blue)
 - a Use and button to select the option.
 - b Use and button to set the value.
 - c After the setup is complete, press the button to exit.
- 3 After the **IP Address, Subnet Mask, Gateway, and DNS** is set up, select **Store** and press button to store the settings.
- 4 If you select **Store** without pressing the **Enter** button, the system will keep the original settings.

RESET—Press to reset network configuration.

WIRELESS SETTINGS—Select and press to activate wireless settings. The wireless settings menu provides the following options:

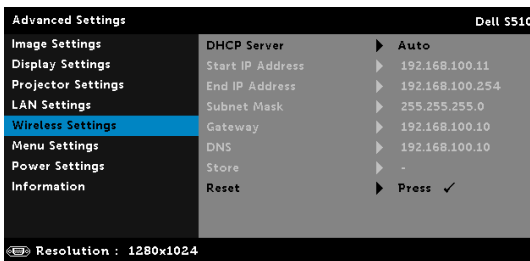

DHCP SERVER—Allows you to enable DHCP server of the wireless.

START IP ADDRESS—Automatically or manually assigns the Start IP address of the DHCP server to the projector connected to the wireless.

END IP ADDRESS—Automatically or manually assigns the End IP address of the DHCP server to the projector connected to the wireless.

SUBNET MASK—Configure the Subnet Mask of the wireless connection.

GATEWAY—Check the Gateway address with your network/system administrator if you configure it manually.

DNS—Check the DNS Server IP address with your network/system administrator if you configure it manually.

STORE—Press to save the changes made in wireless configuration settings.

NOTE:

- 1 Use and button to select IP Address, Subnet Mask, Gateway, DNS, and Store.
- 2 Press the button to enter IP Address, Subnet Mask, Gateway, or DNS to set the value. (The selected option is highlighted in blue)
 - a Use and button to select the option.
 - b Use and button to set the value.
 - c After the setup is complete, press the button to exit.
- 3 After the **IP Address, Subnet Mask, Gateway, and DNS** is set up, select **Store** and press button to store the settings.
- 4 If you select **Store** without pressing the **Enter** button, the system will keep the original settings.

RESET—Press to reset wireless configuration.

MENU SETTINGS—Select and press to activate the menu settings. The menu settings consists of the following options:

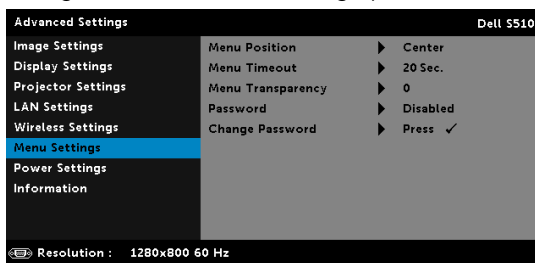

MENU POSITION—Allows you to change the position of the OSD menu on the screen.

MENU TIMEOUT—Allows you to adjust the time for an OSD timeout. By default, the OSD disappears after 20 seconds of non-activity.

MENU TRANSPARENCY—Select to change the transparency level of the OSD background.

PASSWORD—When Password Protect is enabled, a Password Protect screen requesting you to enter a password will be displayed when the power plug is inserted into the electrical output and the power for the projector is first turned on. By default, this function is disabled. You can enable this feature by selecting **Enabled**. If the password has been set before, key in the password first and select the function. This password security feature will be activated the next time you turn on the projector. If you enable this feature, you will be asked to enter the projector's password after you turn on the projector:

1 First time password input request:

- a Go to **Menu Settings**, press  and then select **Password** to enable the password settings.

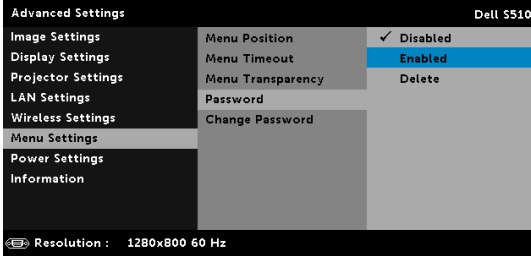

- b Enabling the Password function will pop up a change screen. Key in a 4-digit number from the screen and press .

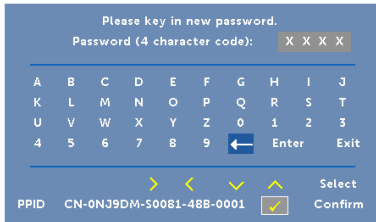

- c To confirm, enter the password again.
- d If the password verification is successful, you may resume with accessing the projector's functions and its utilities.
- 2 If you have entered an incorrect password, you will be given two more chances. After three invalid attempts, the projector will automatically turn off.
-  **NOTE:** If you forget your password, contact DELL or a qualified service person.
- 3 To disable the password function, select the **Disabled** option to close the function.
- 4 To delete the password, select the **Delete** option.

CHANGE PASSWORD—Key in the original password. Then, enter the new password and confirm the new password again.

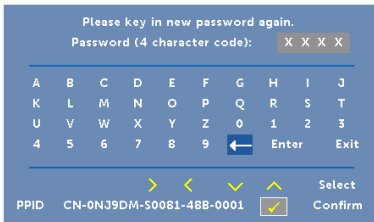
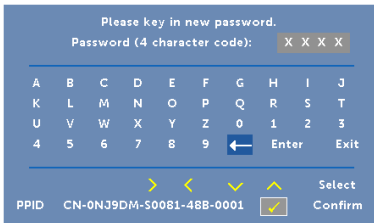
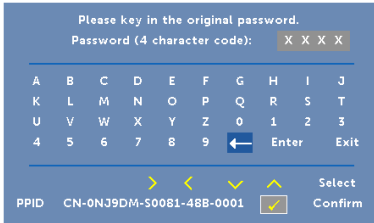

POWER SETTINGS—Select and press to activate power settings. The power settings menu provides the following options:

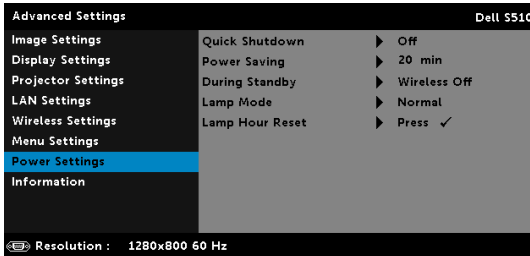

QUICK SHUTDOWN—Select On to turn off the projector with a single press of the Power button. This function allows the projector to quickly power off with an accelerated fan speed. Slightly higher acoustic noise is expected during quick power off.



NOTE: Before you turn on the projector again, wait for 60 seconds to allow the internal temperature to stabilize. The projector will take a longer time to turn on if you try to power on immediately. Its cooling fan will run at full speed for about 30 seconds to stabilize the internal temperature.

POWER SAVING—By default, the projector is set to enter power saving mode after 20 minutes of no activity. A warning message appears on screen showing a 60 seconds countdown before switching to power saving mode. Press any button during the countdown period to stop the power-saving mode.

You can also set a different delay period to enter power saving mode. The delay period is the time you want the projector to wait without an input signal.

If an input signal is not detected during the delay period, the projector turns off. To turn on the projector press the Power button.

DURING STANDBY—Select Wireless On or Off set the Wireless/LAN model on/off while the projector is standby status (default is Wireless Off).

LAMP MODE—Allows you to select the Normal, ECO, Dynamic, or Extreme Dimming mode.

Normal mode operates at full power level. ECO mode operates at a lower power level which may provide longer lamp life, quieter operation, and dimmer luminance output on the screen.

DYNAMIC—Select and press to activate dynamic feature.

EXTREME DIMMING—Select and press to activate extreme dimming feature.

LAMP HOUR RESET—Press and select the Confirm option to reset the lamp hour.

INFORMATION—The information menu displays the current S510 projector settings.

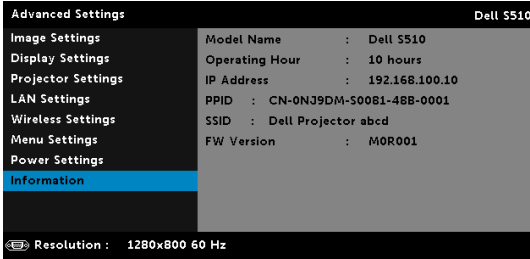

LANGUAGE

Allows you to set the language for the OSD. Press  to activate the Language menu.



HELP

If you encounter problems with your projector, you can access the help menu for troubleshooting.

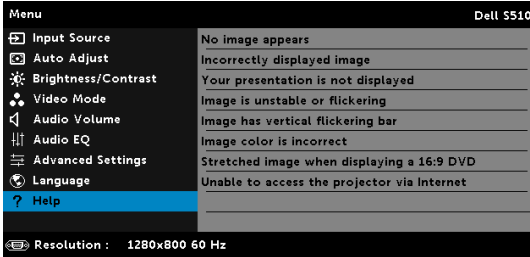

Multimedia Introduction

Multimedia format supported:

Photo Format

Image Type (Ext Name)	Sub Type	Encode Type	Max Pixels
GIF			8000 x 8000
PNG			8000 x 8000
BMP			8000 x 8000
JPEG/JPG	Baseline	YUV420	8000 x 8000
		YUV422	
		YUV440	
		YUV444	
	Progressive	YUV420	8000 x 8000
		YUV422	
		YUV440	
		YUV444	

Video Format

File Format	Max. Resolution	Max. Bit Rate (bps)	Max. Display	Audio Format
Motion JPEG	1920 x 1080, 30fps	20 Mbps	1080p, 60 Hz	LPCM
AVI	1920 x 1080, 30fps	20 Mbps	1080p, 60 Hz	MPEG-1 Layer 3
MPEG-4	1920 x 1080, 30fps	20 Mbps	1080p, 60 Hz	
MOV	1920 x 1080, 30fps	20 Mbps	1080p, 60 Hz	
ASF	1920 x 1080, 30fps	20 Mbps	1080p, 60 Hz	
MKV	1920 x 1080, 30fps	20 Mbps	1080p, 60 Hz	
WMV	1920 x 1080, 30fps	20 Mbps	1080p, 60 Hz	WMA

Music Format

Music Type (ext Name)	Max. Sample Rate (KHz)	Max. Bit Rate (Kbps)
LPCM	48 KHz	320 Kbps
MPEG-1 Layer 3	48 KHz	320 Kbps
WMA	48 KHz	320 Kbps
WAV	48 KHz	320 Kbps
OGG	48 KHz	320 Kbps

How to set-up File Type for Multimedia with USB

 **NOTE:** A USB flash disk must be plugged into the projector if you want to use the multimedia USB function.

Follow these steps to playback the Photo, Video, or Music files on your projector:

- 1 Connect the power cable and turn on the projector by pressing the power button.

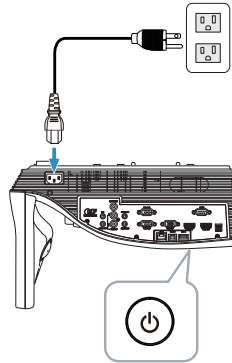

- 2 Plug in a **USB flash disk** to your projector.

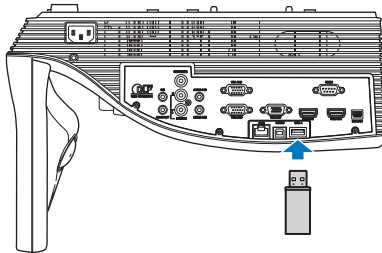

- 3 Press the **Menu** button on the remote control.

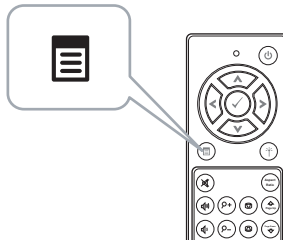

- 4 Access the **Input Source** menu, select **USB** and then select **USB Viewer** on the sub-menu.

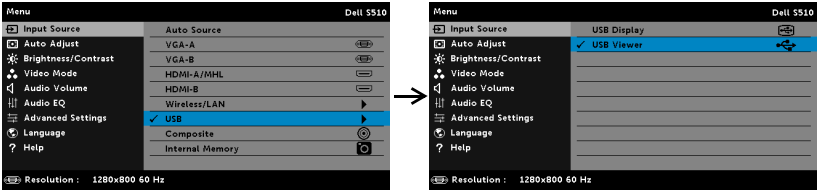

The **USB Screen** shown below appears:

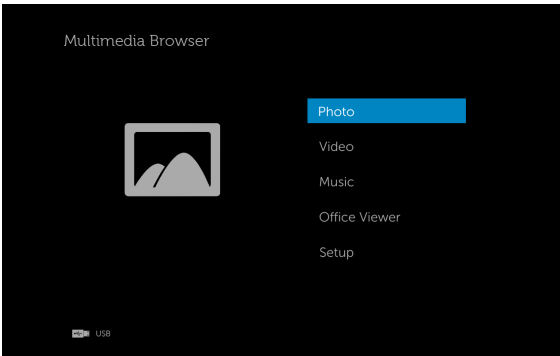

- 5 Select the multimedia files: **Photo**, **Video**, **Music**, or **Office Viewer**, and then press the  to start playing. Or select the **Setup** option to change multimedia settings. See "Multimedia Setup" on page 62.

How to set-up File Type for Multimedia with Internal Memory

Follow these steps to playback the Photo, Video, or Music files on your projector:

- 1 Connect the power cable and turn on the projector by pressing the power button.

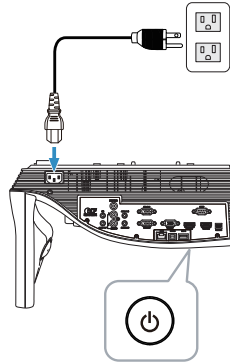

- 2 Press the **Menu** button on the remote control.

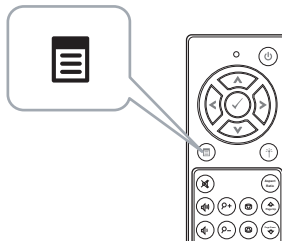

- 3 Access the **Input Source** menu, select **Internal Memory** source.

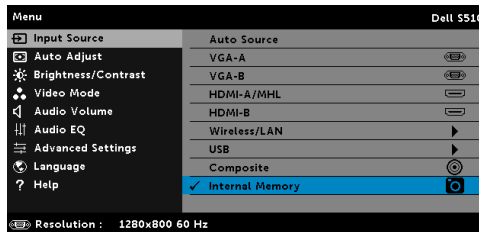

The **Internal Memory Screen** shown below appears:

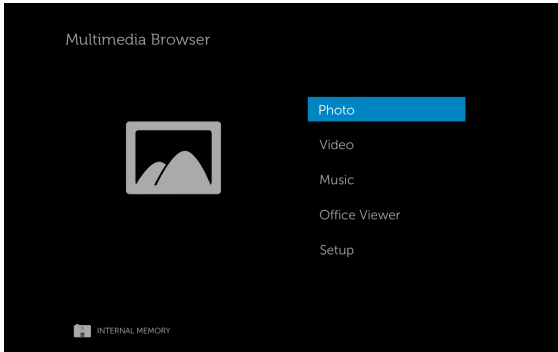

- 4 Select the multimedia files: **Photo**, **Video**, **Music**, or **Office Viewer**, and then press the  to start playing. Or select the **Setup** option to change multimedia settings. See "Multimedia Setup" on page 62.





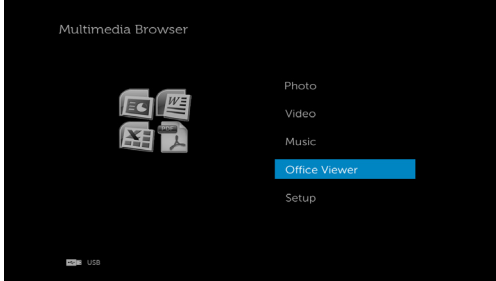

Office Viewer for the USB and Internal Memory

The Office Viewer feature allows you to use MS Excel, MS Word, MS PowerPoint, and PDF files.



Buttons Introduction

Use the up, down, left, and right buttons for navigation and  button on the remote control to select.

Button	Up 	Down 	Left 	Right 	Enter 	Menu 
	No function	No function	Previous page	Next page	No function	Back to previous menu

Multimedia SETUP for USB and Internal Memory

The multimedia setup menu allows you to change settings for Photo, Video, and Music.



NOTE: Multimedia setup menu and set are the same for the USB and internal memory.

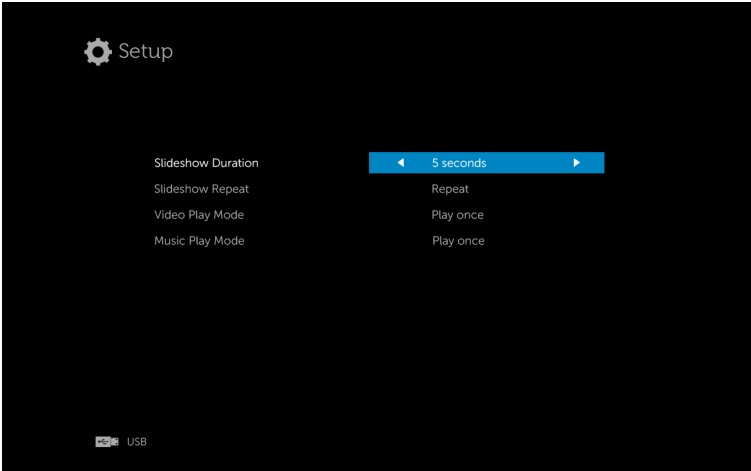

SLIDESHOW DURATION—Press \leftarrow or \rightarrow to select slideshow display interval. The image will automatically switch to the next photo after the time out. Options are: 5 seconds, 10 seconds, 30 seconds, and 1 minute.

SLIDESHOW REPEAT—Press \leftarrow or \rightarrow to select slideshow repeat as Repeat or No Repeat.

VIDEO PLAY MODE—Press \leftarrow or \rightarrow to select movie play mode. Options are: **Play once**, **Repeat item**, **Repeat folder**, and **Shuffle**.

MUSIC PLAY MODE—Press \leftarrow or \rightarrow to select movie play mode. Options are: **Play once**, **Repeat item**, **Repeat folder**, and **Shuffle**.

Using Intel® Wireless Display (WiDi)



NOTE: Your computer must have the following Intel® Wireless Display system requirements:

System Component	Requirement
Processor	<p>One of the following processors is required:</p> <p>2nd generation Intel® Core™ i3/i5/i7 Mobile Processor</p> <p>3rd Generation Intel® Core™ i3/i5/i7 Mobile and Desktop Processor</p> <p>4th Generation Intel® Core™ i3/i5/i7 Mobile and Desktop Processor</p> <p>Intel® Pentium® N3510 Processor</p> <p>Intel® Celeron® N2805 Processor</p> <p>Intel® Celeron® N2810 Processor</p> <p>Intel® Celeron® N2910 Processor</p> <p>Intel® Atom® Z3740 Processor</p> <p>Intel® Atom® Z3740D Processor</p> <p>Intel® Atom® Z3770 Processor</p> <p>Intel® Atom® Z3770D Processor</p>
Graphics	<p>One of the following graphics solutions is required:</p> <p>Intel® Iris™ Pro Graphics 5200</p> <p>Intel® Iris™ Graphics 5100</p> <p>Intel® HD Graphics 5000</p> <p>Intel® HD Graphics 4600</p> <p>Intel® HD Graphics 4400</p> <p>Intel® HD Graphics 4200</p> <p>Intel® HD Graphics 4000</p> <p>Intel® HD Graphics 3000 (mobile)</p> <p>Intel® HD Graphics 2500</p> <p>Intel® HD Graphics 2000 (mobile)</p>

Wireless	<p>One of the following wireless adapters is required:</p> <p>Intel® Centrino® Wireless-N 1000, 1030, 2200, or 2230</p> <p>Intel® Centrino® Wireless-N 2200 for Desktop</p> <p>Intel® Centrino® Advanced-N 6200, 6205, 6230, or 6235</p> <p>Intel® Centrino® Advanced-N 6205 for Desktop</p> <p>Intel® Centrino® Wireless-N + WiMAX 6150</p> <p>Intel® Centrino® Advanced-N + WiMAX 6250</p> <p>Intel® Centrino® Ultimate-N 6300</p> <p>Intel® Dual Band Wireless-N 7260</p> <p>Intel® Dual Band Wireless-AC 7260</p> <p>Intel® Dual Band Wireless-AC 7260 for Desktop</p> <p>Intel® Dual Band Wireless-AC 3160</p> <p>Intel® Wireless-N 7260</p> <p>Broadcom BCM43228</p> <p>Broadcom BCM43241</p> <p>Broadcom BCM4352</p>
Software	<p>Intel® My Wi-Fi Technology (Intel® MWT) and Intel® Wireless Display must be pre-installed and enabled.</p>
Operating System	<p>One of the following operating systems is required:</p> <p>Microsoft Windows 7</p> <p>Microsoft Windows 8</p> <p>Microsoft Windows 8.1</p>

For most up-to-date information, visit Intel® WiDi website at www.intel.com/go/widi

Enable Intel® WiDi on Projector

- 1 Connect the power cable and press the power button.

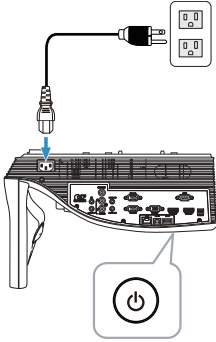

- 2 Press the **Menu** button on the remote control.

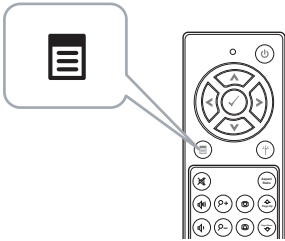

NOTE: Use , , , and  buttons to navigate and  to select.

- 3 Access the **Input Source** menu, select **Wireless/LAN** and then select **Intel® WiDi/Miracast** on the sub-menu.

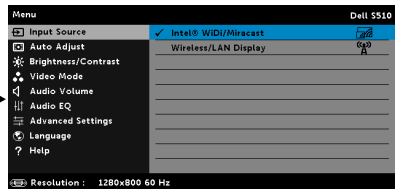
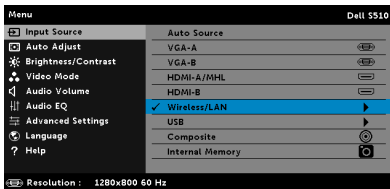

The **Intel® WiDi Guide Screen** shown below appears:



- 4 Take note of the **ADAPTER NAME** and **PIN CODE**. You will need this information to log-in later.

Using Intel® WiDi with Microsoft Windows 7 and Windows 8



NOTE: Get the latest Intel® WiDi Software to ensure the best experience, go to <http://www.intel.com/go/wirelessdisplayupdate>.

- 1 Type WiDi in your Windows search bar. If your computer has built-in Intel® WiDi, you will see the "Intel® WiDi" application in your search results.
- 2 Connect your computer to Dell Projector.

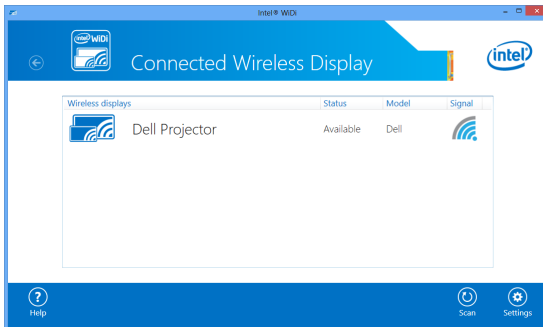

- 3 Key in Security Code as provided in Step 4 of Enable Intel® WiDi on Projector, for pairing confirmation.

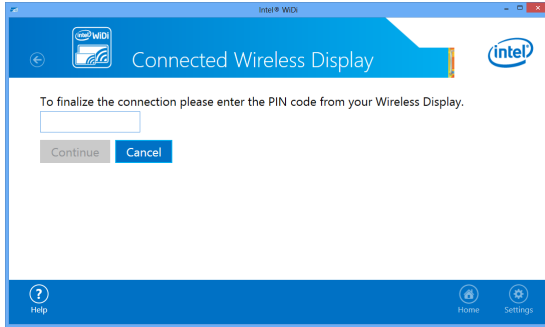

Renaming Intel® WiDi Adapter

- 1 Select "Settings".

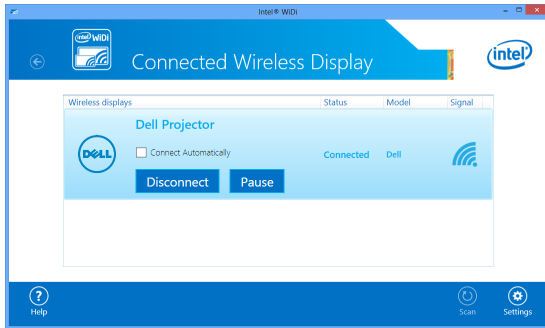

- 2 Select "Current Display Settings".

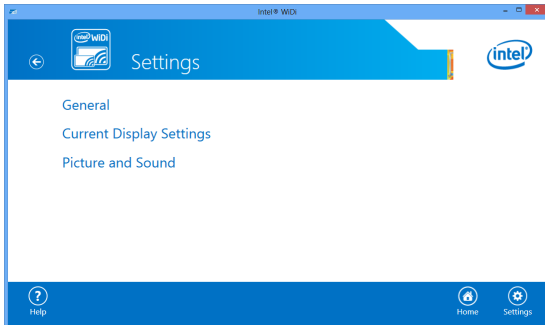

- 3 You may type a new descriptive name for the adapter.

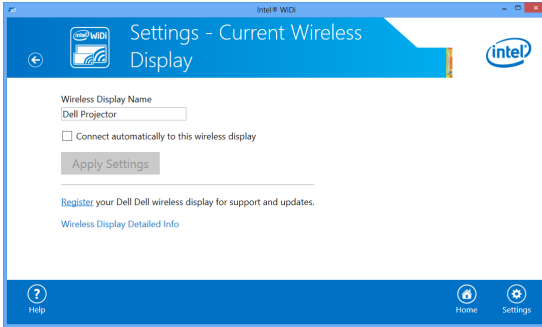

Using Intel® WiDi with Microsoft Windows 8.1



NOTE: The Intel® WiDi features are accessed differently in Windows 8.1, and the Intel® WiDi software is not needed.

- 1 Bring up the **Devices** Charm.

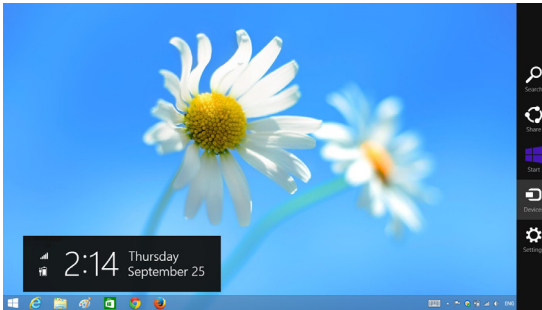

- 2 Select "**Project**".

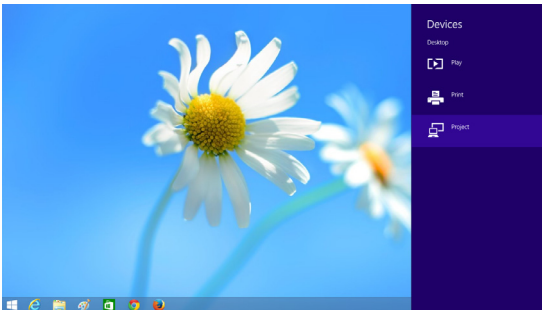

- 3 Select **"Add a wireless display"**.

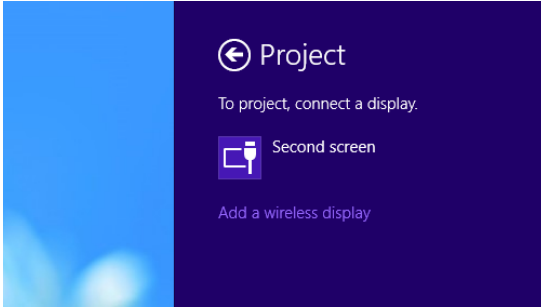

- 4 Choose detected **Dell Projector**.

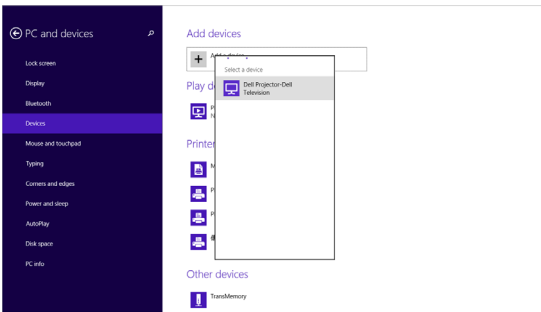

- 5 Key in PIN as provided in Step 4 of Enable Intel® WiDi on Projector for pairing confirmation.

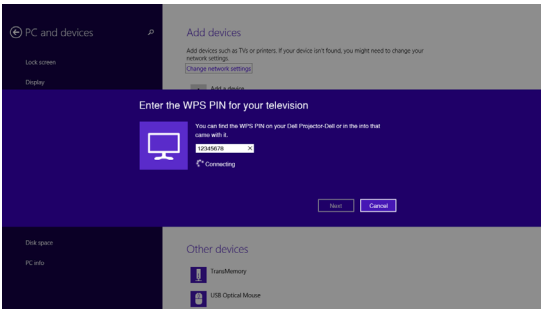

6 Screen is projected.



7 To adjust projection modes or disconnect, bring up the Devices Charm, select "**Project**". Alternatively, use the shortcut "**Win + P**" for direct toggle.

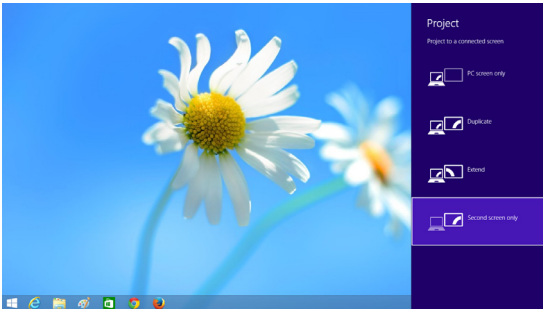

Wireless Display or LAN Display Installation



NOTE: Your computer must have the following minimum system requirements:

Operating System:

- Windows
Microsoft Windows XP Home or Professional Service pack 2 (32-bit recommended), Windows Vista 32-bit, and Windows 7 Home or Professional 32-bit or 64-bit, Windows 8 32-bit or 64-bit
- MAC
MacBook and above, MacOS 10.5 and above

Minimum Hardware:

- a** Intel Dual Core 1.4 MHz or higher
- b** 256 MB of RAM required, 512 MB or more recommended
- c** 10 MB of available hard-disk space
- d** nVIDIA or ATI graphic card with 64 MB VRAM or above
- e** Ethernet adapter (10/100 bps) for an Ethernet connection
- f** A supported WLAN adapter for a WLAN connection (any NDIS-compliant 802.11b or 802.11g or 802.11n Wi-Fi device)

Web browser

Microsoft Internet Explorer 6.0 or 7.0 (recommended) or 8.0, Firefox 2.0, Safari 3.0, and above

For Windows Operating System Settings

Enable Wireless or LAN on the Projector

- 1 Connect the power cable and press the power button.

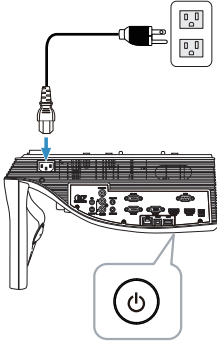

- 2 Press the **Menu** button on the remote control.

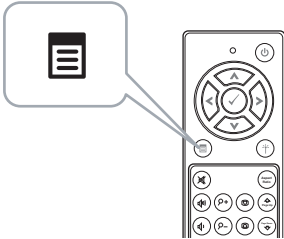

NOTE: Use , , , and  buttons to navigate and  to select.

- 3 Access the **Input Source** menu, select **Wireless/LAN** and then select **Wireless/LAN Display** on the sub-menu.

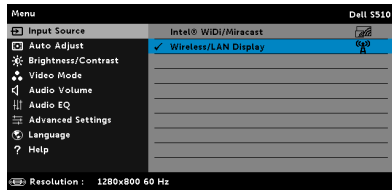
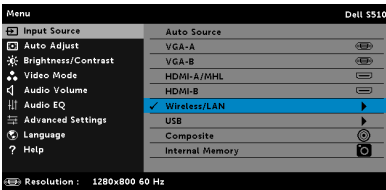

The **Wireless Guide Screen** shown below appears:



For First-time Connection



1. Connect your computer to the projector's wireless network (SSID):

Dell Projector abcd



2. Open web browser and enter the IP Address into your browser's address bar:

192.168.100.10



3. Click on 'Download' and run the installation program

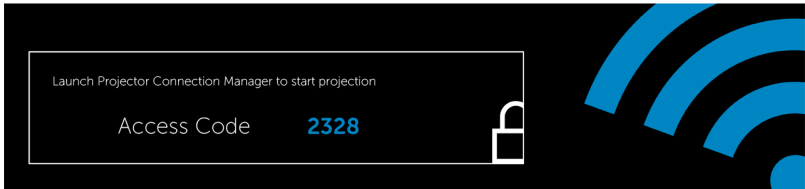

4 Take note of the **Wireless Network (SSID)**, **IP Address**, and **Access Code**. You will need this information to log-in in later.

For Wireless display settings, go to **Step 5**.

For LAN display settings, go to **Step 11**.

Install the Dell Projector Connection Manager on Your Computer by Wireless

5 Connect your computer to the Dell S510 abcd wireless network.

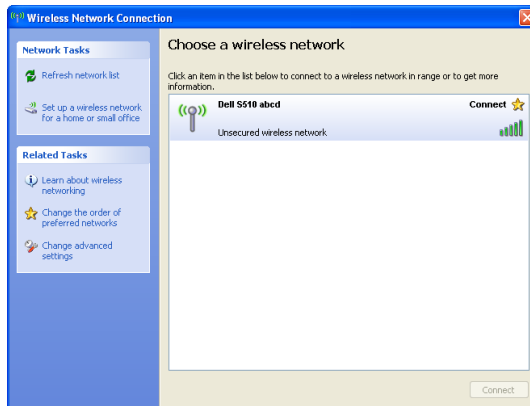



NOTE:

- Your computer must have wireless network function to detect the connection.
- When you connect to the Dell S510 abcd wireless network, you will lose wireless connectivity with other wireless networks.



NOTE: Remember to turn off all proxies. (In Microsoft® Windows Vista: Click **Control Panel** → **Internet Options** → **Connections** → **LAN Settings**)

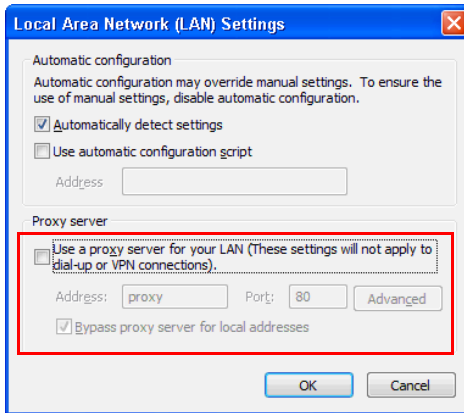

- 6 Open your internet browser. You will be automatically directed to the **S510 Web Management** web page.



NOTE: If the web page does not load automatically, enter the IP address (default IP address is 192.168.100.10) noted from the projector's screen in the browser's address bar.



- 7 The S510 Web Management page opens. For first-time use, click **Download**.

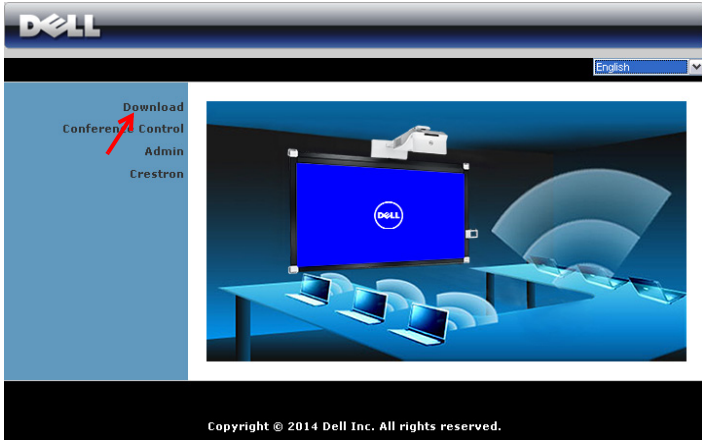

- 8 Select the appropriate operating system, then click **Download**.

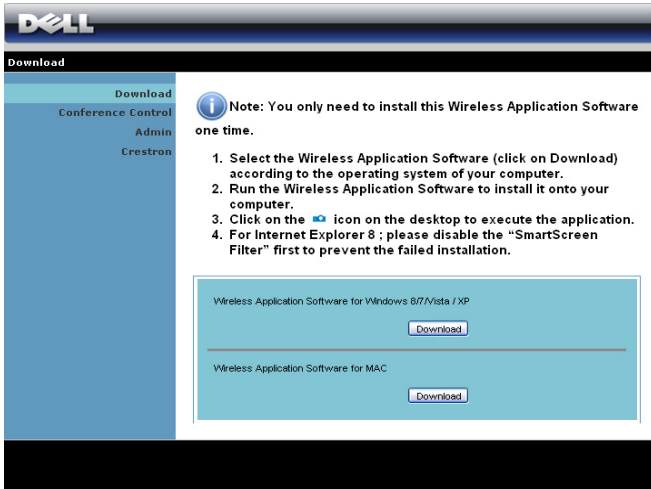

- 9 Click **Run** to proceed with the one-time installation of the software.



NOTE: You may choose to save the file and install it at a later time. To do this, click **Save**.

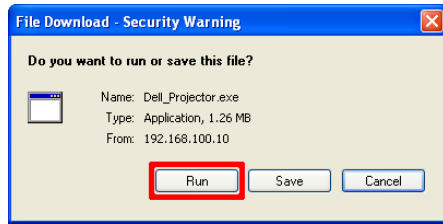

NOTE: Audio projection function needs install extra driver only in Windows XP. If your computer does not have the driver installed, a pop-up message will appear on-screen prompting you to install the required driver. You can download the “**Audio Projection Driver**” from the Dell Support site at dell.com/support.



NOTE: If you are unable to install the application because of inadequate rights on the computer, please contact your network administrator.

- 10 The installation software will launch. Follow the on-screen instruction to complete setup.

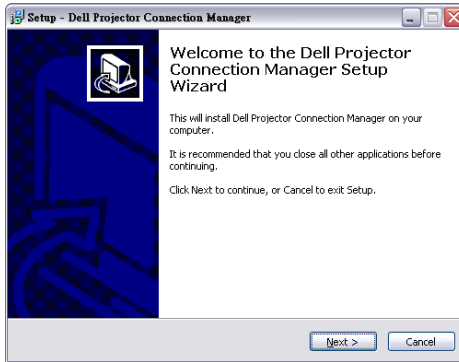

Launch the Dell Projector Connection Manager

Once the installation is complete, the program will launch and search automatically. If the program does not launch automatically, you can double-click the  icon on the desktop to start the application.



Login

Login with the Access Code provided in Step 4 of Wireless Display or LAN Display Installation, then click OK.

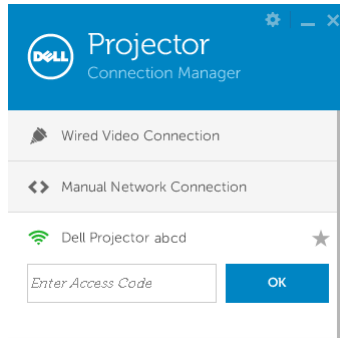

Install the Dell Projector Connection Manager on Your Computer by LAN

- 11 The installation software will launch. Follow the on-screen instruction to complete setup.

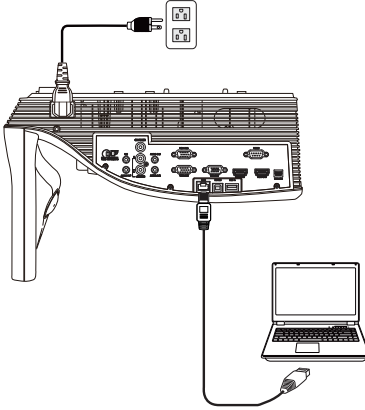

- 12 Repeat **steps 6 - 10** to install Dell Projector Connection Manager.

Launch and Login the Dell Projector Connection Manager

Once the installation is complete, the program will launch and search automatically. If the program does not launch automatically, you can double-click the  icon on the desktop to start the application.

- a Click the **"Manual Network Connection"** (Fig.1).
- b Enter **IP Address** (Fig.2, default IP address: 192.168.100.10).
- c Enter **Access Code** (Fig.3).

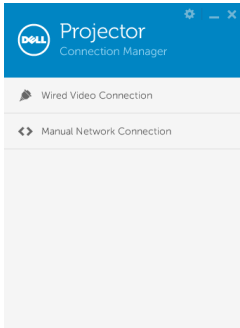

(Fig.1)

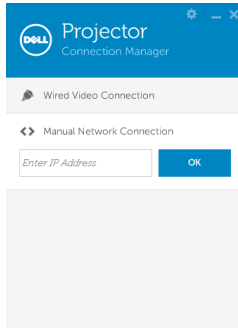

(Fig.2)

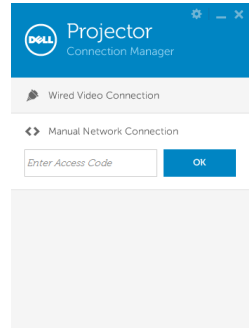







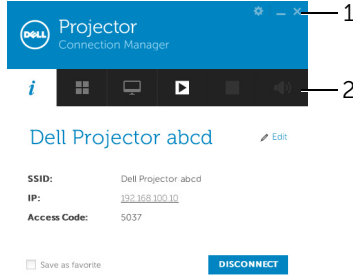



(Fig.3)

Understanding the Buttons

After a successful log in, the following screen appears:



Item	Description	
1	Status Bar	
	Settings	Click to activate the application settings.
	Minimize button	Click to minimize the application.
	Close button	Click to exit the application.
2	Controls Toolbar	
	Information	Click to display SSID, IP, and Access Code information.
	Share mode	Click to activate the share mode.
	Display mode	Click to change the display mode.
	Start	Click to start projection.
	Pause	Click to pause projection.
	Stop	Click to stop projection.
	Audio	Click to toggle audio projection On/Off.

Using the Settings

Click  to display the settings menu.

RESOLUTION—Allows you to setup the resolution.

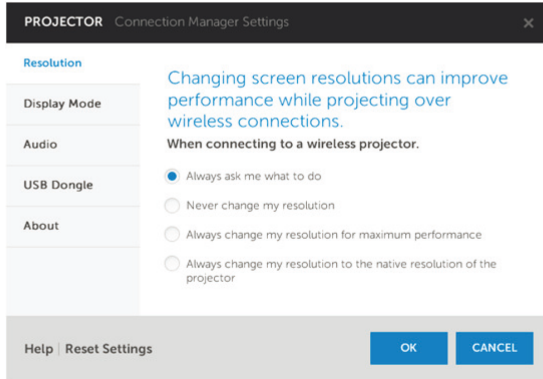

DISPLAY MODE—Allows you to setup the default projection mode.

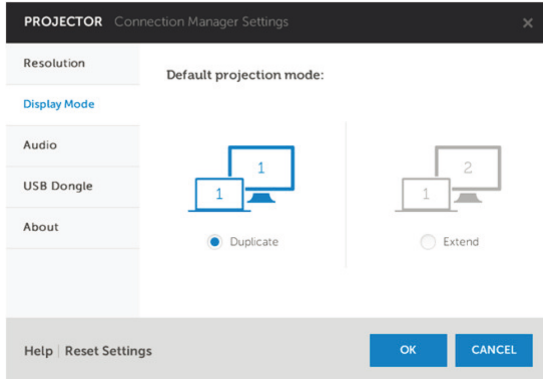

AUDIO—Allows you to change the audio settings.

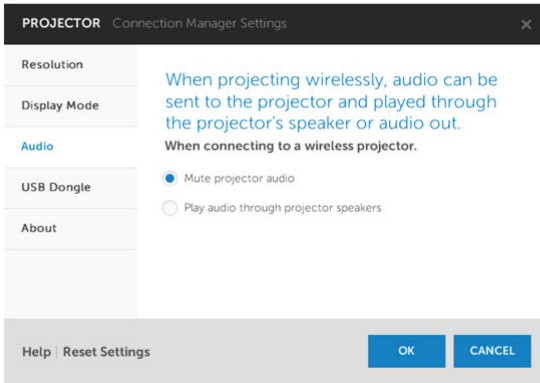

USB DONGLE—Allows you to create USB dongle. See "Make Application Token" on page 132.

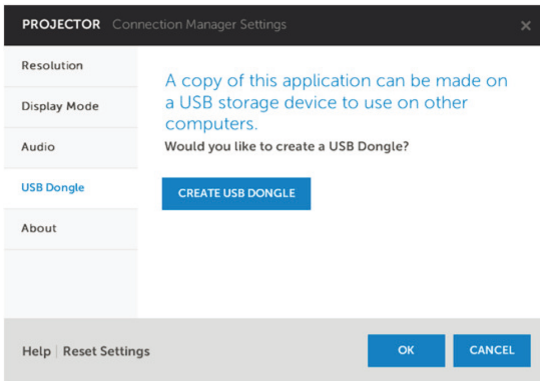

ABOUT—Display the application version.

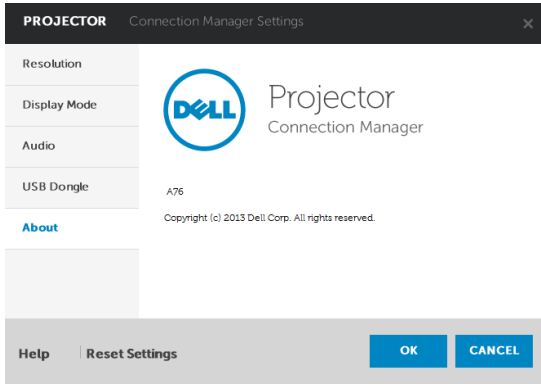

For Mac Operating System Settings

Enable Wireless or LAN on the Projector

- 1 Connect the power cable and press the power button.

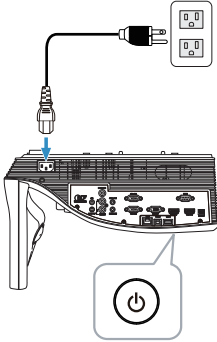

- 2 Press the **Menu** button on the remote control.

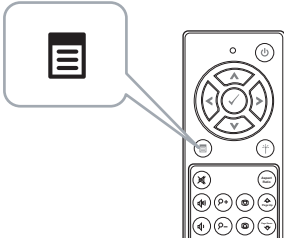

NOTE: Use , , , and  buttons to navigate and  to select.

- 3 Access the **Input Source** menu, select **Wireless/LAN** and then select **Wireless/LAN Display** on the sub-menu.

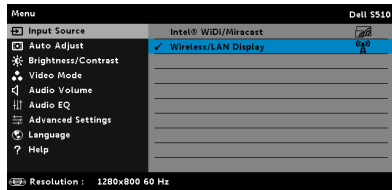
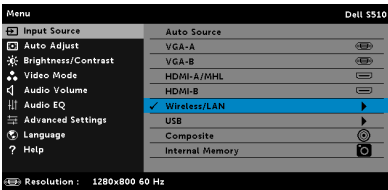

The **Wireless Guide Screen** shown below appears:

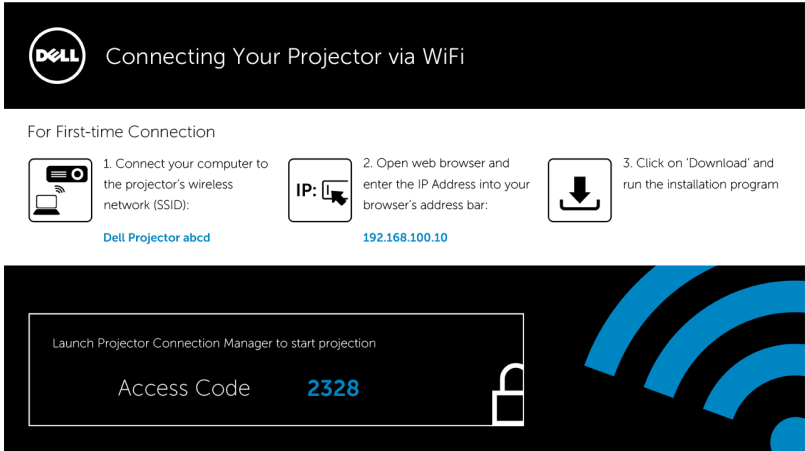

- 4 Take note of the **Wireless Network (SSID)**, **IP Address**, and **Access Code**. You will need this information to log-in in later.

For Wireless display settings, go to **Step 5**.

For LAN display settings, go to **Step 11**.

Launch the Dell Wireless Application Software on Your Computer by Wireless

- 5 Connect your computer to the Dell S510 abcd wireless network.
 - 6 Open your Safari browser. You will be automatically directed to the **S510 Web Management** web page.
-  **NOTE:** If the web page does not load automatically, enter the IP address (default IP address is 192.168.100.10) noted from the projector's screen in the browser's address bar.
- 7 The S510 Web Management page opens. For first-time use, click **Download**.
 - 8 Select the appropriate operating system, then click **Download**.
 - 9 Execute the **Dell_S510.dmg** file from downloaded folder.
 - 10 Execute the **Dell S510 Wireless Application** from Dell S510 folder.

Login

Login with the Access Code provided in Step 4 of Wireless Display or LAN Display Installation, then click Connect.

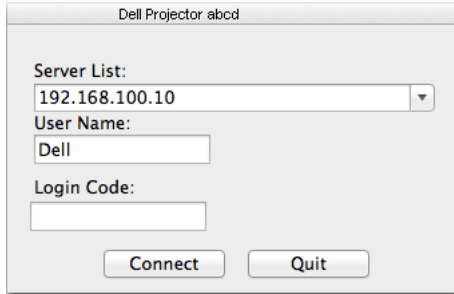

The screenshot shows a window titled "Dell Projector abcd". It contains three input fields: "Server List:" with a dropdown menu showing "192.168.100.10", "User Name:" with a text box containing "Dell", and "Login Code:" with an empty text box. At the bottom, there are two buttons: "Connect" and "Quit".

Launch the Dell Wireless Application Software on Your Computer by LAN

- 11 Connect the LAN cable to the projector and the computer.
- 12 Repeat **steps 6 - 10** to launch the Dell Wireless Application.

Login

Login with the Access Code provided in Step 4 of Wireless Display or LAN Display Installation, then click Connect.

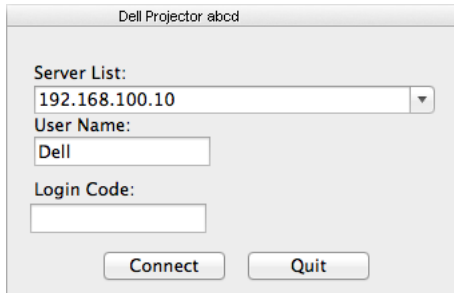













The screenshot shows a window titled "Dell Projector abcd". It contains three input fields: "Server List:" with a dropdown menu showing "192.168.100.10", "User Name:" with a text box containing "Dell", and "Login Code:" with an empty text box. At the bottom, there are two buttons: "Connect" and "Quit".





Understanding the Buttons

After a successful log in, the following screen appears:



	Item	Description
1	Status Bar	Displays IP and LOGIN CODE information.
	 Menu	Click to activate the application menu.
	 Minimize button	Click to minimize the application.
	 Close button	Click to exit the application.
2	Controls Toolbar	
	 Full screen	Click to project the image in full screen.
	 Split 1	Click to project the image in the upper left corner of the screen.
	 Split 2	Click to project the image in the upper right corner of the screen.
	 Split 3	Click to project the image in the lower left corner of the screen.
	 Split 4	Click to project the image in the lower right corner of the screen.
	 Stop	Click to stop projection.
	 Pause	Click to pause projection.
 Audio Projection	Click to enable audio projection.	
3	Connection Status	
	 Connection Icon	Blinks when projection is in progress.

Projecting the Presentation

- To project the presentation, click any of the projection buttons .
- To pause the presentation, click . The icon turns green.
- To continue the presentation, click  again.
- To audio projection the presentation, click .
- To stop the presentation, click .



NOTE: WLAN environment using 802.11g connection, and no screen stretching.

Using the Menu

Click  to display the menu.

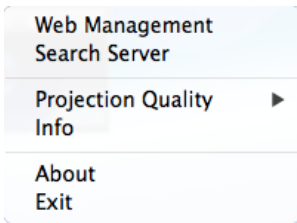

WEB MANAGEMENT—Click to open the Web Management page. See “IR Pen Interactivity Installation” on page 104.

SEARCH SERVER—Click to search and connect to wireless projector.

PROJECTION QUALITY—Allows you to set the projector quality is **Blur but Faster** or **Clear but Slower**.

INFO—Click to display system information.

ABOUT—Click to display the application version.

EXIT—Click to close the application.

Audio Projection Installation

Audio Projection only supports the **Wireless Display** and **LAN Display** input source.

Minimum system requirements are as follow:

Operating System:

- Windows
Microsoft Windows XP™ Home or Professional Service pack 2/3 (32-bit recommended), Windows Vista 32-bit, or Windows® 7 Home or Professional 32-bit or 64-bit, Windows 8 32-bit or 64-bit
- Mac
MacBook Pro and above, MacOS 10.5 and above

Minimum Hardware:

- a Intel® Core™ i5-460 MHz (2.53 GHz/Turbo 2.8 GHz) or greater
- b 1 GB DDR3 VRAM independent graphics card or more recommended
- c 2 GB dual channel DDR3 SDRAM memory at 1066 MHz required or more recommended
- d Gigabit Ethernet
- e Integrated 802.11 a/b/g/n Wi-Fi Device for a WLAN connection



NOTE: If your computer does not meet the minimum hardware requirements, audio projection may have lag or noise. Meet the recommended system requirements to have optimized performance of audio projection.



NOTE: Audio projection function needs install extra driver only in Windows XP, If your computer does not have the driver installed, a pop-up message will appear on-screen prompting you to install the required driver. You can download the "**Audio Projection Driver**" from the Dell Support site at dell.com/support.



NOTE: Audio Projection function needs installed extra driver in Mac operating system. If your Mac computer does not have the driver installed, a pop-up message will appear on-screen prompting you to install the required driver. You can download the "**Soundflower**" driver from the some search engine sites (ex. Yahoo, MSN...). The "**Soundflower**" driver is a free application.



NOTE: Ports / Protocol for connection to the projector for projection via Ethernet:

UDP:	1047,	(backup: 1048, 1049)
TCP:	3268, 515, 1688, 1041	(backup: 389, 8080, 21)

For Windows Operating System Settings

Enable Wireless or LAN on the Projector

- 1 Connect the power cable and press the power button.

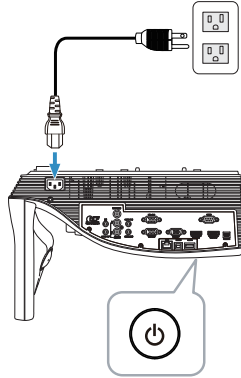

- 2 Press the **Menu** button on the remote control.

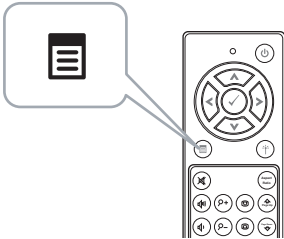

- 3 Access the **Input Source** menu, select the **Wireless/LAN** and then select the **Wireless/LAN Display** on the sub-menu.

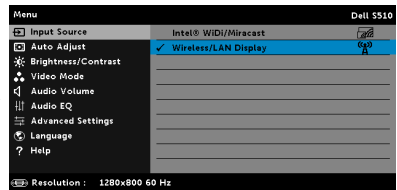
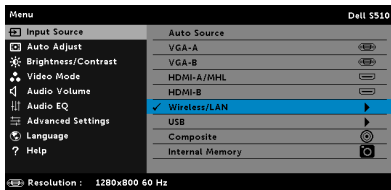

The **Wireless Guide Screen** shown below appears:

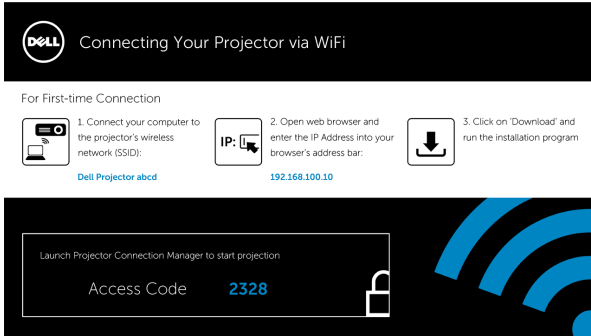

- 4 Take note of the **Wireless Network (SSID)**, **IP Address**, and **Access Code**. You will need this information to log-in later.
For Wireless display settings, go to **Step 5**.
For LAN display settings, go to **Step 7**.

Install the Dell Projector Connection Manager on Your Computer by Wireless

- 5 "Dell Projector Connection Manager" is required if the Wireless or LAN is used for the audio projection set-up. Please download and install the software the first time you use audio projection. If it is already installed, skip **Step 5 - 6**.



NOTE: You only need to install the "Dell Projector Connection Manager Software" once.

- 6 Dell Projector Connection Manager Software download and install steps, you can refer to steps 6 to 10 of the "Wireless Display or LAN Display Installation" on page 71.

Launch the Dell Projector Connection Manager

Once the installation is complete, the program will launch and search automatically. If the program does not launch automatically, you can double-click the  icon on the desktop to start the application.

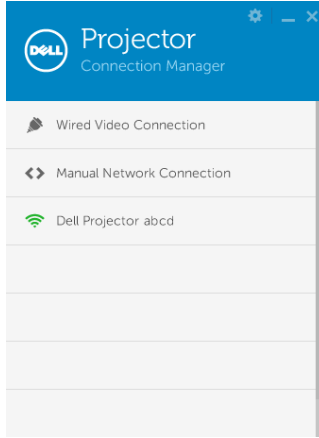

Login

Login with the Access Code provided in Step 4 of Audio Projection Installation, then click OK.

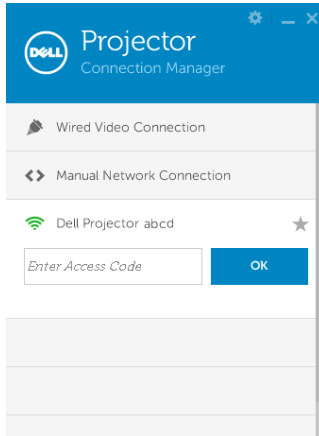

Install the Dell Projector Connection Manager on Your Computer by LAN

- 7 Connect the LAN cable to the projector and the computer.
- 8 Refer to **step 6** to install Dell Projector Connection Manager.

Launch the Dell Projector Connection Manager

Once the installation is complete, the program will launch and search automatically. If the program does not launch automatically, you can double-click the  icon on the desktop to start the application.

- a Click the "**Manual Network Connection**" (Fig.1).
- b Enter **IP Address** (Fig.2, default IP address: 192.168.100.10).
- c Enter **Access Code** (Fig.3).

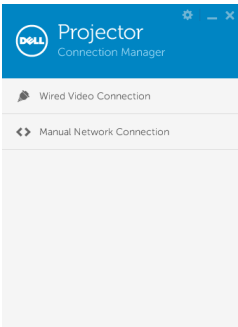

(Fig.1)

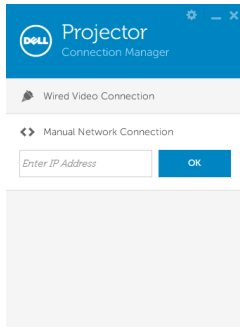

(Fig.2)

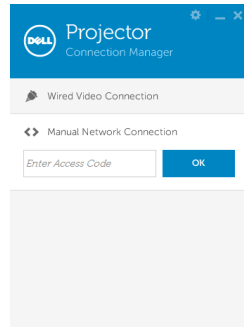

(Fig.3)

Using the Audio Projection

- 9 You are now logged into the Dell Projector Connection Manager. Click the **"Play"** button in the application to starting the LAN or wireless audio projection.

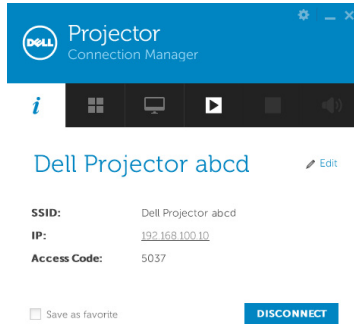

- 10 Click the "Audio Projection" button in the application to toggle audio projection On/Off.

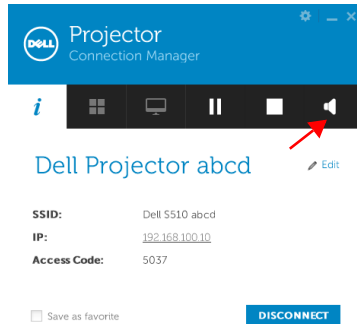

NOTE: Audio projection function needs install extra driver only in Windows XP. If your computer does not have the driver installed, a pop-up message will appear on-screen prompting you to install the required driver. You can download the "Audio Projection Driver" from the Dell Support site at dell.com/support.

- 11 Executing the Windows Media Player or others audio player software (example: Winamp player...) on your computer.



For Mac Operating System Settings

Enable Wireless or LAN on the Projector

- 1 Connect the power cable and press the power button.

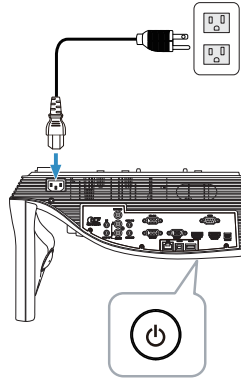

- 2 Press the **Menu** button on the remote control.

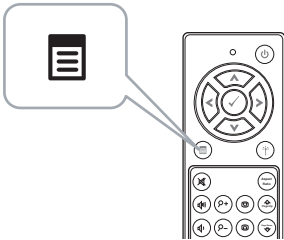

- 3 Access the **Input Source** menu, select the **Wireless/LAN** and then select the **Wireless/LAN Display** on the sub-menu.

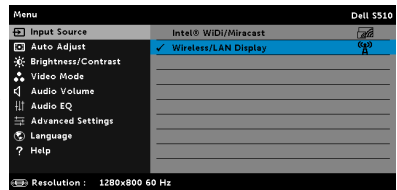
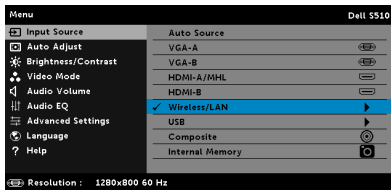

The **Wireless Guide Screen** shown below appears:

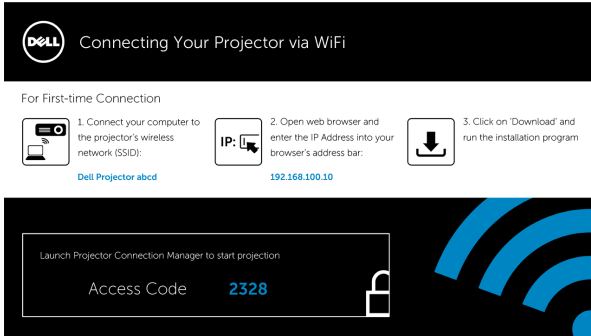

- 4 Take note of the **Wireless Network (SSID)**, **IP Address**, and **Access Code**. You will need this information to log-in later.
For Wireless display settings, go to **Step 5**.
For LAN display settings, go to **Step 14**.

Launch the Dell Wireless Application Software on Your Computer by Wireless

- 5 Connect your computer to the Dell S510 abcd wireless network.
 - 6 Open your Safari browser. You will be automatically directed to the **S510 Web Management** web page.
-  **NOTE:** If the web page does not load automatically, enter the IP address (default IP address is 192.168.100.10) noted from the projector's screen in the browser's address bar.
- 7 The S510 Web Management page opens. For first-time use, click **Download**.
 - 8 Select the application operating system, then click **Download**.
 - 9 Execute the **Dell_S510.dmg** file from downloaded folder.
 - 10 Execute the **Dell S510 Wireless Application** from Dell S510 folder.

Login

Login with the Access Code provided in Step 4 of Audio Projection Installation, then click Connect.

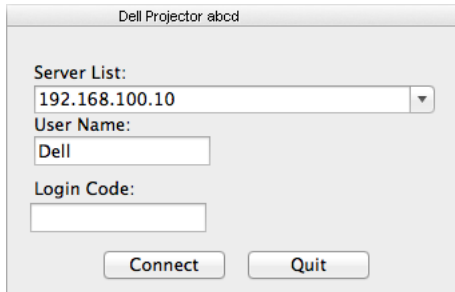

- 11 You are now logged into the S510 Wireless Application. Click "Play" button in the application to starting the wireless or LAN projection.



- 12 Click "Audio Projection" button in the application to toggle audio projection On/Off.



 **NOTE:** Audio projection function needs installed extra driver in Mac operating system. If your Mac computer does not have the driver installed, a pop-up message will appear on-screen prompting you to install the required driver. You can download the "**Soundflower**" driver from the some search engine sites (ex. Yahoo, MSN...). The "**Soundflower**" driver is a free application. See "Install the Soundflower Driver" on page 100.

- 13 Executing the audio player software on your computer.

Launch the Dell Wireless Application Software on Your Computer by LAN

- 14 Connect the LAN cable to the projector and the computer.
- 15 Repeat **steps 6 - 13** to launch and login the Dell Wireless Application.

Install the Soundflower Driver

- 1 You can download the **"Soundflower"** driver from the some search engine sites (ex. Yahoo, MSN...). The **"Soundflower"** driver is a free application.
- 2 Execute the **"Soundflower.dmg"** file from downloaded folder.
- 3 Execute the **"Soundflower.pkg"** file from Soundflower folder.

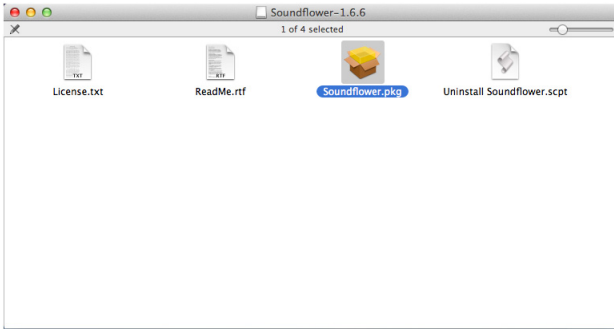

- 4 The installation software will launch. Follow the on-screen instruction to complete setup.

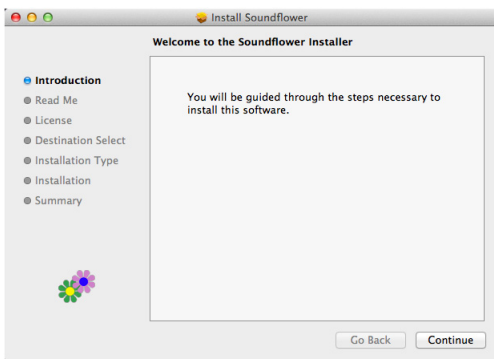

USB Display (DoUSB) Installation

For Windows Operating System

- 1 Connect the power cable and press the power button.

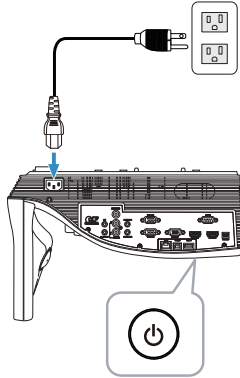

- 2 Connect the USB (type A to B) cable to the projector and the computer.
- 3 When you connect the projector and computer via USB cable, a USB Connected message will pop up and allow you to select **DoUSB** or **Storage Mode**. Select "**DoUSB**" option to switch to the USB Display source.

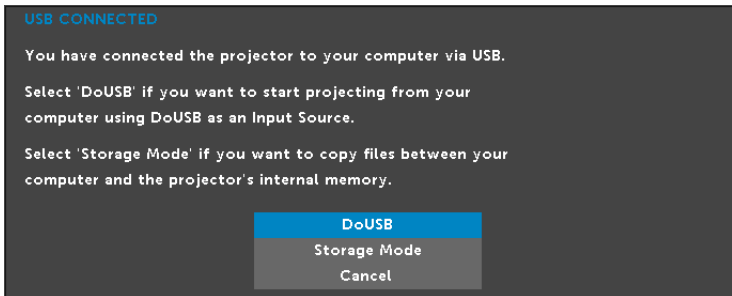

NOTE: If the DoUSB can't display, please see "Troubleshooting Your Projector" on page 133.

For Mac Operating System

- 1 Connect the power cable and press the power button.

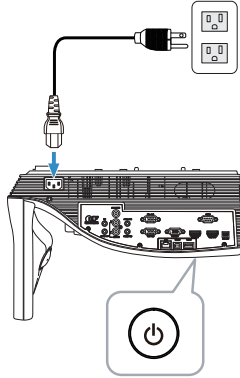

- 2 Connect the USB (type A to B) cable to the projector and the computer.
- 3 When you connect the projector and computer via USB cable, a USB Connected message will pop up and allow you to select **DoUSB** or **Storage Mode**. Select "**DoUSB**" option to switch to the USB Display source.

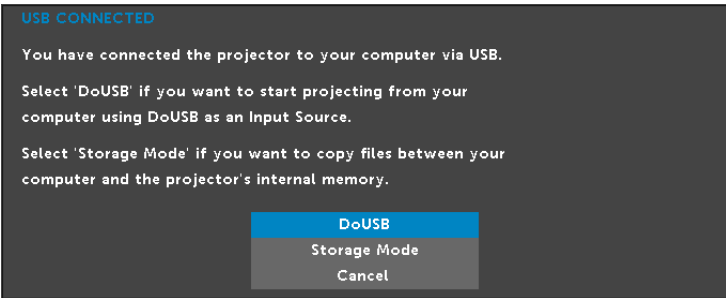

NOTE: DoUSB function needs install driver in Mac operating system. If your Mac computer does not have the driver installed, a pop-up message will appear on-screen prompting you to install the required driver. See "Install the DoUSB Driver" on page 103.

Install the DoUSB Driver

- 1 Double-click the **"USB_DISPLAY"** icon on the desktop.
- 2 Execute the **"MAC_USB_Display.pkg"** file from USB_DISPLAY folder.

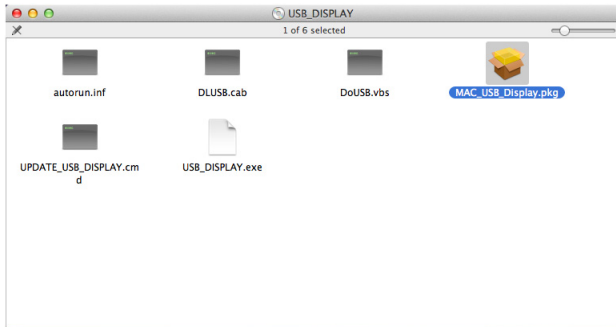

- 3 The installation software will launch. Follow the on-screen instruction to complete setup.

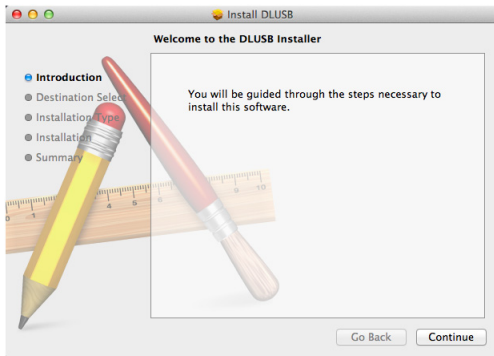

- 4 When installation is completed, restart your computer.

IR Pen Interactivity Installation



NOTE: Your computer must have the following minimum system requirements:

Operating System:

- Windows

Windows XP Professional service pack 3 32-bit, Windows 7 32-bit/64-bit, Windows 8 32-bit/64-bit, and Windows 8.1 32-bit/64-bit

Windows .NET Framework 4.0 installation is required (You can download it from the Microsoft site)

- Mac

MacOS 10.6 and above

Minimum Hardware:

- a Windows processor type: Intel Core i3 or above
- b MAC processor type: Intel Core i2 duo or above
- c Windows/MAC RAM: 2 GB of RAM required or more are recommended
- d Windows/MAC Min. HDD space: 110 MB of available hard-disk space

For Windows Operating System Settings

- 1 Connect power, VGA, mini USB cables to projector.

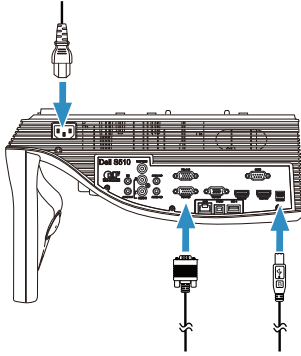

- 2 Power on the projector by pressing the power button on the remote control.

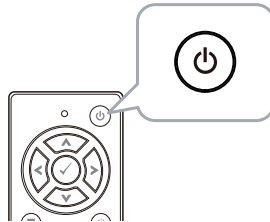

- 3 Connect VGA and mini USB cables to your computer.

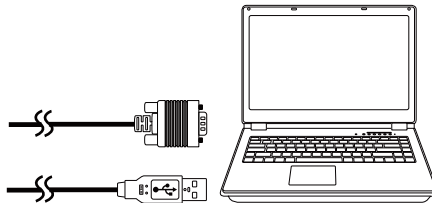

- The PenDriver install message will pop-up automatically after you plug in the USB cable to your computer. Follow the on-screen instruction to complete setup.

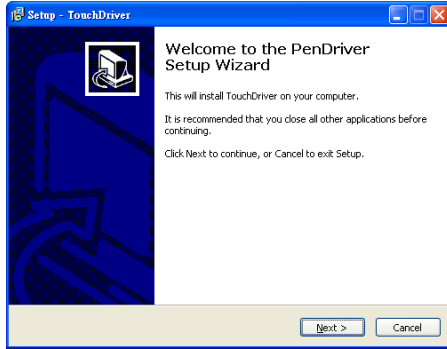

The driver icon  will appear in your computer's notification area if the driver has installed successfully.

If the Pen driver is not automatically installed, go to **My Computer** and run "PenDriver.exe".



NOTE: You may require administrator-level access to install the driver. Contact your network administrator for support.

- Click the Pen driver  icon, select **Calibrate pen** and then select **Auto** on the sub-menu.

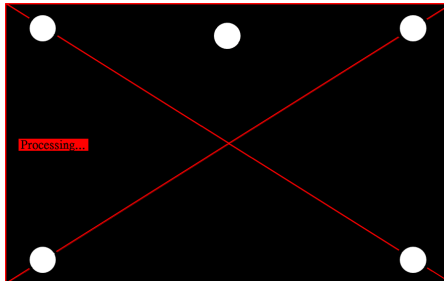

If the "**auto calibrate failed**" message prompts, please take the steps below for troubleshooting, then do auto calibrate again.

- Turn lights off or reduce stray light to whiteboard
- Do not walk in front of or move the projector

c Adjust focus to sharpen the projected image

If the "**auto calibrate still failed**" message appears on screen, please change to manual calibrate.

Manual Calibrate:

Click the Pen driver  icon, select **Calibrate pen** and then select **Manual** on the sub-menu.

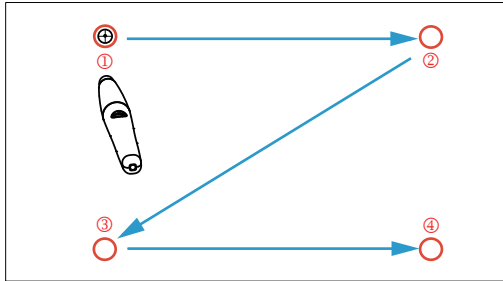

Touch the target marks on the screen. (Press the "ESC" key to exit the calibration process). After the 4th point of calibration is finished, please wait for 2 seconds while the calibration data is saved.

- 6 Turn on the power switch of the IR Pen.
- 7 Point the IR Pen to the screen, and start using your IR Pen.

For Mac Operating System Settings

- 8** Repeat **steps 1 - 3** to turn on the projector power and connect VGA and USB cables.
- 9** Search CD-ROM of the PenDriver in your computer.
- 10** Double-click PenDriver.zip file from the MAC folder.
- 11** Execute the PenDriver.app in the Download folder.
- 12** Refer to **steps 5 - 7** to execute the initialize the control function and start using your IR Pen.

Managing the Projector From Web Management

Configuring the Network Setting

If the projector is connected to a network, you can access the projector using a web browser. For configuring the network setting, refer to "LAN Settings" on page 48.

Accessing Web Management

Use Internet Explorer 6.0 and above or Firefox 2.0 and above and enter the IP address. You can now access Web Management and manage the projector from a remote location.

Home Page

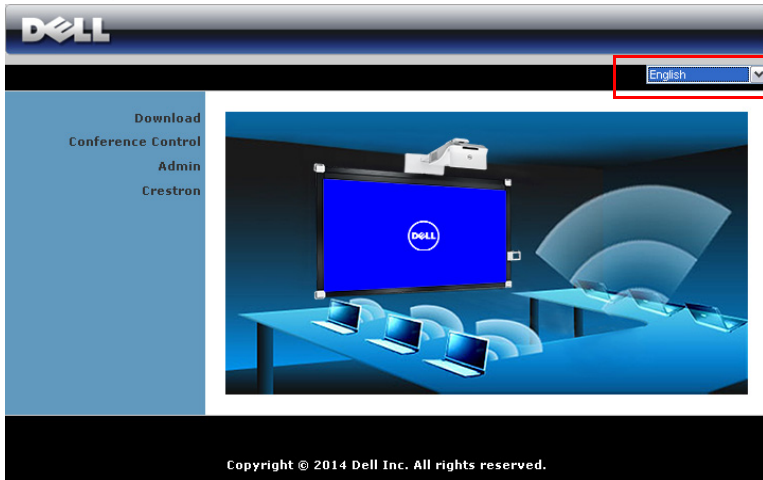

- Access the Web Management Home page by entering the projector's IP address at the web browser. See "LAN Settings" on page 48.
- Select the language for web management from the list.
- Click any menu item on the left tab to access the page.

Download the Dell Projector Connection Manager

See also "Wireless Display or LAN Display Installation" on page 71.

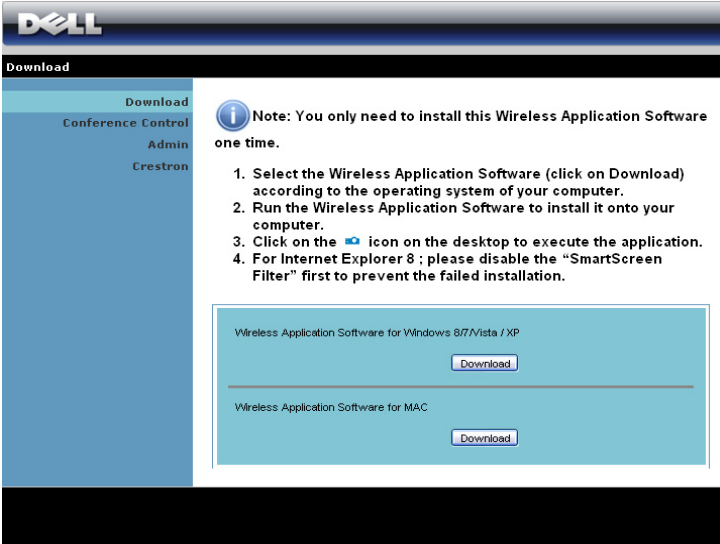

The screenshot shows a Dell website page for downloading software. At the top is the Dell logo. Below it is a navigation menu with options: Download, Conference Control, Admin, and Crestron. The 'Download' option is highlighted. To the right of the menu is a blue sidebar with a white 'i' icon and the text: 'Note: You only need to install this Wireless Application Software one time.' Below the note is a numbered list of four steps: 1. Select the Wireless Application Software (click on Download) according to the operating system of your computer. 2. Run the Wireless Application Software to install it onto your computer. 3. Click on the [icon] icon on the desktop to execute the application. 4. For Internet Explorer 8 ; please disable the "SmartScreen Filter" first to prevent the failed installation. Below the list is a light blue box containing two download options: 'Wireless Application Software for Windows 87/Vista / XP' with a 'Download' button, and 'Wireless Application Software for MAC' with a 'Download' button.

Click the **Download** button of the corresponding operating system of your computer.

Conference Control

This allows you to host conference presentations from different sources without using projector cables and lets you control how each presentation will appear on screen.



NOTE: Without Conference Play Control, the last user to hit the "Play" button on the application will take control of the full-screen projection.

Computer Name: Lists the computers logged for conference control.

Play Control: Click the buttons to control how each computer's projection will appear on screen.

- Full screen projection — The presentation from the computer occupies the whole screen.
- Split 1 - The presentation from the computer appears on the upper left corner of the screen.
- Split 2- The presentation from the computer appears on the upper right corner of the screen.
- Split 3- The presentation from the computer appears on the lower left corner of the screen.
- Split 4- The presentation from the computer appears on the lower right corner of the screen.
- Stop - Projection from the computer is stopped.

IP Address: Shows each computer's IP Address.

NOTE: To end the conference, click **Home**.

Managing Properties

Admin

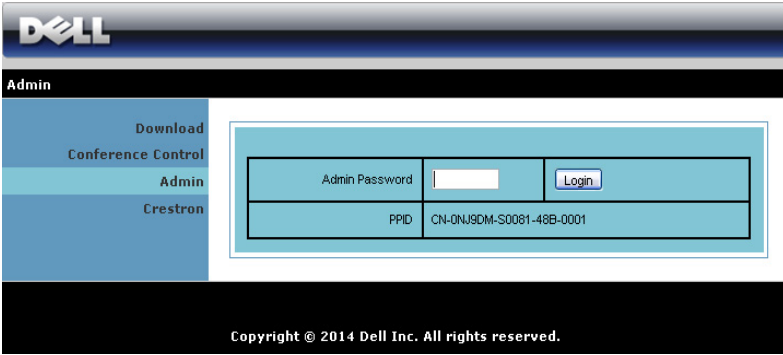

An administrator password is required to access the Admin page.

- **Admin Password:** Enter the administrator password and then click **Login**. The default password is "admin". To change the password, see "Change Passwords" on page 117.

System Status

The screenshot displays the Dell System Status web interface. At the top, there is a Dell logo and a navigation bar with 'Admin > System Status' and a 'Home' button. The main content area is split into a left sidebar and a main table.

System Status

- Network Setup
- Projection Setup
- Change Passwords
- Reset to Default
- Firmware Upgrade
- Projector Control Panel
- Alert Setting
- Reboot System

Network Status

IP Address	192.168.100.10
Subnet Mask	255.255.255.0
Default Gateway	192.168.100.10
Wire MAC Address	00:12:5F:00:00:00

Connection Status

Projecting Status	Waiting for Projecting
Total Users	0

Projector Status

Model Name	S510
Projector Name	Dell Projector
Location	
Contact	
Status	On
Lamp Hours	2 hrs

Displays the **Network Status**, **Connection Status**, and **Projector Status** information.

Network Status

See OSD section on page 48.

Admin > Network Setup Home »

System Status
Network Setup
Projection Setup
Change Passwords
Reset to Default
Firmware Upgrade
Projector Control Panel
Alert Setting
Reboot System

IP Setup

Obtain an IP address automatically Use the following IP address

IP Address: 192 . 168 . 100 . 10

Subnet Mask: 255 . 255 . 255 . 0

Default Gateway: 192 . 168 . 100 . 10

DNS Server: 192 . 168 . 100 . 10

DHCP Server Setup

Auto Disable

Start IP: 192 . 168 . 100 . 11

End IP: 192 . 168 . 100 . 254

Subnet Mask: 255 . 255 . 255 . 0

Default Gateway: 192 . 168 . 100 . 10

DNS Server: 192 . 168 . 100 . 10

Wireless Setup

Wireless LAN: Enable Disable

Region: ---- WORLDWIDE ----

SSID: Dell Projector abcd

SSID Broadcast: Enable Disable

Frequency Band: 2.4G B/G/N mixed

Channel: Auto

Encryption: Disable

Key: _____

TX mode channel: 20MHz 40MHz

RADIUS Server Setup

IP Address: 192 . 168 . 100 . 10

Port: 1812

Key: _____

GateKeeper

All Pass All Block Internet Only

Set Security For SNMP

Write Community: _____

Apply Cancel

IP Setup

- Choose **Obtain an IP address automatically** to assign an IP address to the projector automatically, or **Use the following IP address** to assign an IP address manually.

DHCP Server Setup

- Choose **Auto** to automatically set up the **Start IP**, **End IP**, **Frequency Band**, **Subnet Mask**, **Default Gateway**, and **DNS Server** address from a DHCP server, or **Disable** to disable this function.

Wireless Setup

- Choose **Enable** to set up the **Region, SSID, SSID Broadcast, Frequency Band, Channel, Encryption, Key** and **TX mode channel**. Choose **Disable** to disable the wireless set up.

SSID: Up to maximum length of 32 characters.

Encryption: You can disable WPA key or select one of 64-bit or 128-bit in ASCII or HEX string.

Key: If Encryption is enabled, you have to set key value according to the Encryption mode you selected.

RADIUS Server Setup

- Set up the IP address, Port, and Key information.

GateKeeper

- There are three options:

All Pass: Allow users to access the office network via the wireless projector.

All Block: Block users from accessing the office network via the wireless projector.

Internet Only: Block users from the office network, but still reserve Internet connection capability.

Set Security For SNMP

- Setup Write Community information.

Click the **Apply** button to save and apply changes. The projector must be restarted for the changes to take effect.

Projection Setup

Admin > Projection Setup Home »

Projection Setup	Resolution	WXGA (1280x800) ▾
	Login Code	<input type="radio"/> Disable <input type="radio"/> Random <input type="radio"/> Use the following code <input type="text"/>
Projector Setup	Model Name	S510
	Projector Name	<input type="text" value="Dell Projector"/>
	Location	<input type="text"/>
	Contact	<input type="text"/>

Projection Setup

- **Resolution:** Allows you to select the resolution. Options are: XGA (1024 x 768) and WXGA (1280 x 800).
- **Login Code:** Select how you want the login code to be generated by the projector. There are three options:
 - **Disable:** Login code will not be required when logging in to the system.
 - **Random:** Default is **Random**. Login code will be randomly generated.
 - **Use the following code:** Enter a 4-digit code. This code will be used to log in to the system.

Projector Setup

- Set up the **Projector Name**, **Location**, and **Contact** information (up to 21 characters for each field).

Click the **Apply** button to save and apply changes. The projector must be restarted for the changes to take effect.

Change Passwords

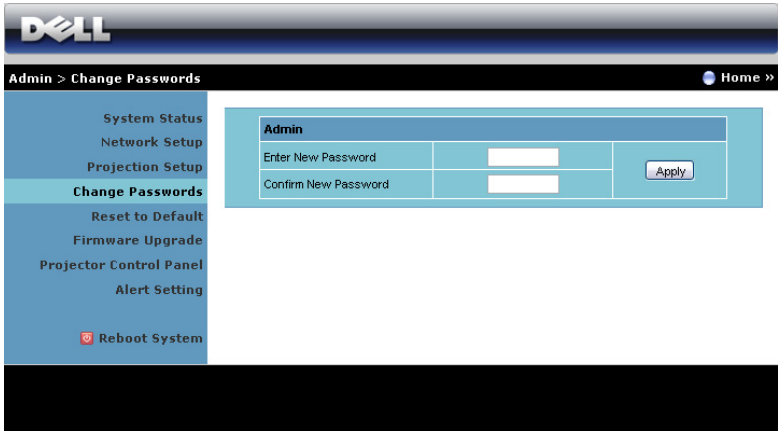

The screenshot shows the Dell Admin interface. At the top left is the Dell logo. Below it, the breadcrumb navigation reads "Admin > Change Passwords". On the right side of the header, there is a "Home" link with a right-pointing arrow. A left-hand navigation menu lists several options: "System Status", "Network Setup", "Projection Setup", "Change Passwords" (which is highlighted in a darker blue), "Reset to Default", "Firmware Upgrade", "Projector Control Panel", "Alert Setting", and "Reboot System" (with a red power icon). The main content area is titled "Admin" and contains a form with two input fields: "Enter New Password" and "Confirm New Password". An "Apply" button is located to the right of the second input field.

This page allows you to change the administrator password.

- **Enter New Password:** Enter the new password.
- **Confirm New Password:** Enter the password again and click **Apply**.



NOTE: Contact Dell if you forget your administrator password.

Reset to Default

The screenshot shows the Dell Admin console interface. At the top, there is a dark blue header with the 'DELL' logo on the left and a 'Home' link with a right-pointing arrow on the right. Below the header, a breadcrumb trail reads 'Admin > Reset to Default'. On the left side, there is a vertical navigation menu with the following items: 'System Status', 'Network Setup', 'Projection Setup', 'Change Passwords', 'Reset to Default' (highlighted in a light blue bar), 'Firmware Upgrade', 'Projector Control Panel', 'Alert Setting', and 'Reboot System' (with a red square icon containing a white 'x'). The main content area is a light blue box with a yellow warning triangle icon on the left. The text in this box reads: 'Reset to Default' followed by 'This will restore the Wireless/Network to factory default settings.' At the bottom of this box is a button labeled 'Apply'.

Click the **Apply** button to restore the wireless/network setup to its factory default settings.

Firmware Upgrade

Use the Firmware Upgrade page to update your projector's wireless firmware.

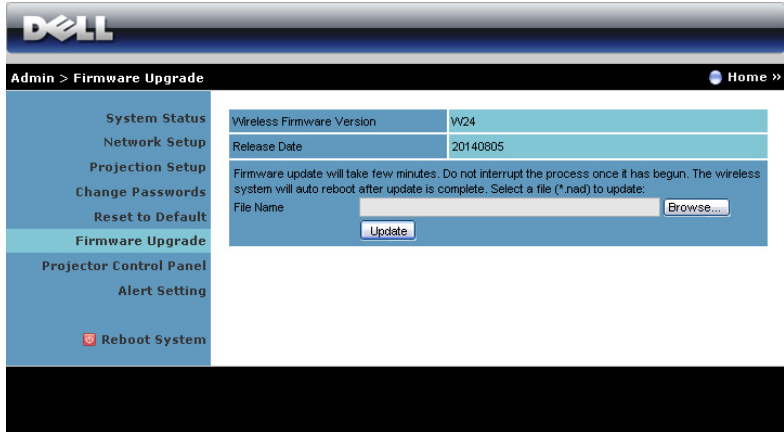

NOTE: Please disable and enable wireless/network using the OSD to restart the network card for the projector after firmware upgrade is successful.

To start firmware update, follow these steps:

- 1 You can download the firmware files from **dell.com/support**.
- 2 Press **Browse** to select the file to update.
- 3 Click the **Update** button to start. Wait while the system updates the firmware in your device.

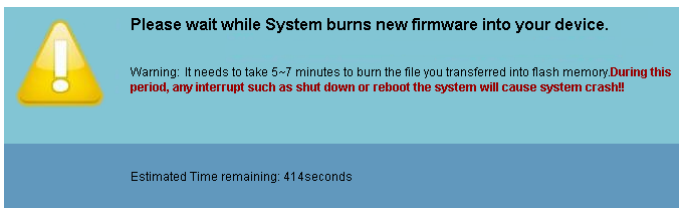

CAUTION: Do not interrupt the update process as this may cause the system to crash!

- 4 Click **OK** when the update is complete.

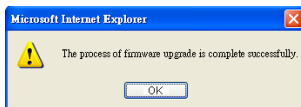

Projector Control Panel

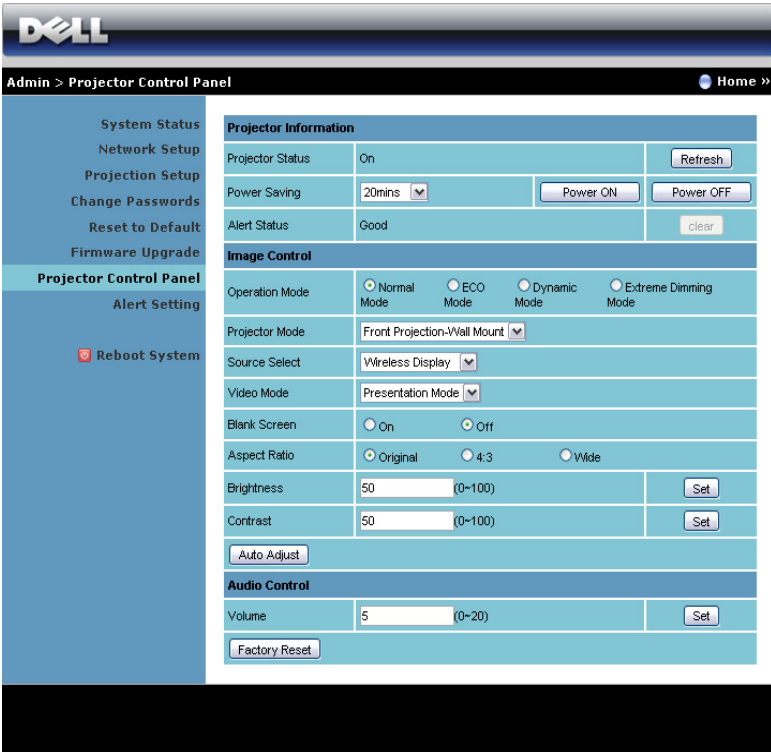

Projector Information

- **Projector Status:** There are five states: Lamp On, Standby, Power Saving, Cooling, and Warming up. Click **Refresh** to refresh the status and control settings.
- **Power Saving:** Power Saving can be set to Off, 20, 60, 90, or 120 minutes. For more information, see "Power Saving" on page 53.
- **Alert Status:** There are three alert states: Lamp warning, Low lamp life, and Temperature warning. Your projector might lock up in the protection mode if any of the alerts are activated. To exit the protection mode, click **Clear** to clear the Alert Status before you power on your projector.

Image Control

- **Projector Mode:** Allows you to select the projector mode, depending on how the projector is mounted. There are two projection modes: Front Projection-Wall Mount and Rear Projection-Wall Mount.
- **Source Select:** The Source Select menu allows you to select your projector's input source. You can select VGA-A, VGA-B, Composite Video, HDMI-A, HDMI-B, Wireless Display, USB Display, USB Viewer, Intel® WiDi, or Internal Memory.
- **Video Mode:** Select a mode to optimize the display image based on how the projector is being used:
 - **Presentation:** Best for presentation slides.
 - **Bright:** Maximum brightness and contrast.
 - **Movie:** For viewing movies and photos.
 - **sRGB:** Provides a more accurate color representation.
 - **Custom:** User-preferred settings.
- **Blank Screen:** You can select On or Off.
- **Aspect Ratio:** Allows you to select the aspect ratio to adjust how the image appears.
- **Brightness:** Select value to adjust the brightness of the image.
- **Contrast:** Select value to adjust the display contrast.

Click the **Auto Adjust** button to adjust the settings automatically.

Audio Control

- **Volume:** Select the value (0~20) for audio volume.

Click the **Factory Reset** button to restore the factory default settings.

Alert Setting

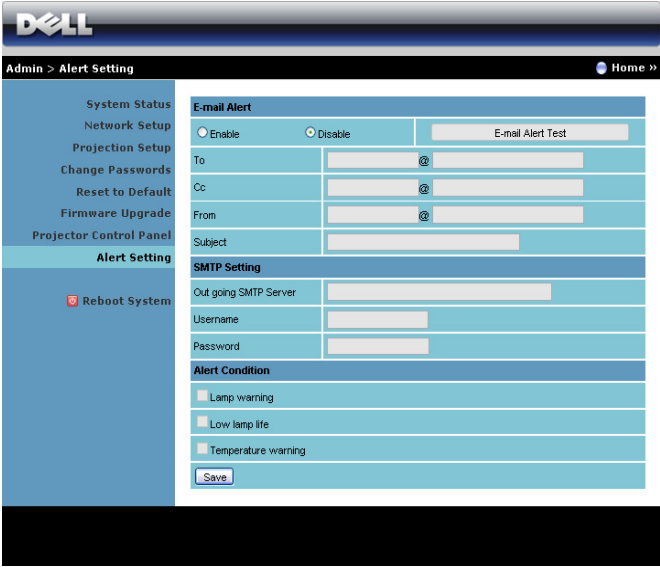

E-mail Alert

- E-mail Alert: You can set whether to be notified by email (Enable) or not (Disable).
- To/Cc/From: You can enter email address of sender (From) and recipients (To/Cc) to receive notification when an abnormality or warning occurs.
- Subject: You can enter the subject line of the email.

Click the **E-mail Alert Test** button to test the e-mail alert settings.

SMTP Setting

- **Out going SMTP server**, **User name**, and **Password** should be provided by your network administrator or MIS.

Alert Condition

- You can select the abnormalities or warnings to be notified by email. When any of the alert conditions occur, an email will be sent to the recipients (To/Cc).

Click the **Save** button to the save settings.



NOTE: E-mail alert is designed to work with a standard SMTP server using the default 25 port. It does not support encryption and authentication (SSL or TLS).

Reboot System

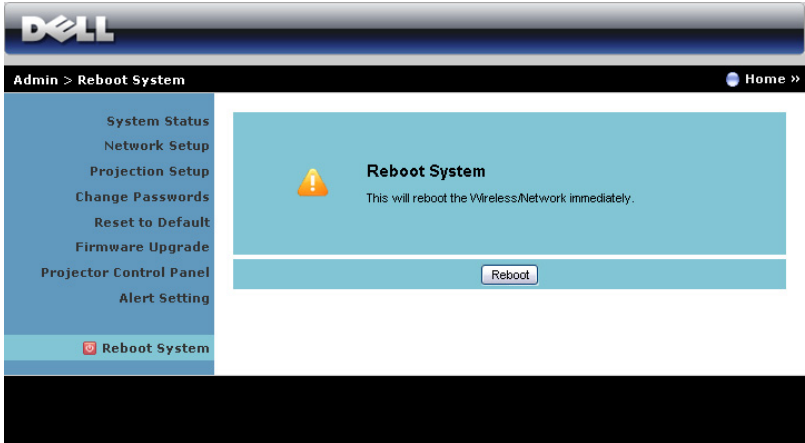

Click **Reboot** to reboot the system.

Crestron

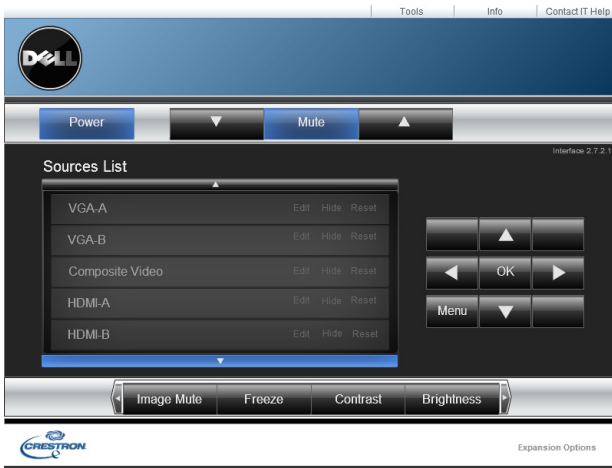

	Item	Description
1	Power button	Click to toggle projector power On/Off.
2	Volume control bars	Click up to increase the volume. Click Mute to toggle projector speaker On/Off. Click down to decrease the volume.
3	OSD navigation pad	Click Menu to toggle projector OSD On/Off. Use the arrow keys to navigate the OSD options and click OK to select.
4	Brightness button	Click to adjust the projector display brightness.
5	Contrast button	Click to adjust the projector display contrast.
6	Freeze button	Click to toggle projector screen image freeze On/Off.
7	Image mute button	Click to toggle projector display On/Off. This function will not turn the projector power On/Off.
8	Sources list panel	Allows you to switch the projector's input source.

Using the Tools Window

The following window is displayed when you click the Tools tab on the operation window. You can use this window to change settings in the projector that is currently connected.

The screenshot shows a web-based configuration interface for a Dell Crestron projector. The interface is organized into three main columns: 'Crestron Control', 'Projector', and 'User Password'. The 'Crestron Control' column includes input fields for IP Address, IP ID (set to 5), and Port (set to 41794), with a 'Send' button below. The 'Projector' column includes fields for Projector Name (S510), Location, and Assigned To, with a 'Send' button below. The 'User Password' column features an 'Enabled' checkbox, a 'New Password' field, and a 'Confirm' field, with a 'Send' button below. Below these columns are 'DHCP' settings (Enabled checkbox, IP Address: 192.168.100.10, Subnet Mask: 255.255.255.0, Default Gateway: 192.168.100.10, DNS Server: 192.168.100.10) and 'Admin Password' settings (Enabled checkbox, New Password field, Confirm field, Send button). An 'Exit' button is centered at the bottom. The Dell logo is in the top left, and the Crestron logo and 'Expansion Options' text are at the bottom.

Crestron Control

- Make settings for Crestron® central controllers.

Projector

Item	Description
1 Projector Name	Enter a name to differentiate the projector that is currently connected from other projectors on the network. (The name can contain up to 15 single-byte alphanumeric characters.)
2 Location	Enter an installation location name for the projector that is currently connected on the network. (The name can contain up to 32 single-byte alphanumeric characters and symbols.)
3 Assigned To	Enter a user name for the projector. (The name can contain up to 32 single-byte alphanumeric characters and symbols.)

	Item	Description
4	DHCP	Select the Enabled check box to use DHCP. You cannot enter an IP address if DHCP is enabled.
5	IP Address	Enter the IP address to assign to the currently connected projector.
6	Subnet Mask	Enter a subnet mask for the currently connected projector.
7	Default Gateway	Enter the gateway address for the currently connected projector.
8	DNS Server	Enter the DNS server IP address for the currently connected projector.
9	Send	Click this button to confirm the changes made to the projector.

User Password

Select the **Enabled** check box to require a password to open the operation window on the computer.

	Item	Description
1	New Password	Enter the new password when changing the password to open the operation window. (Up to 26 single-byte alphanumerical characters)
2	Confirm	Enter the same password as you entered in New Password. If the passwords are not the same, an error is displayed.
3	Send	Click this button to confirm the changes made to the User Password.

Admin Password

Select the **Enabled** check box to require a password to open the Tools window.

	Item	Description
1	New Password	Enter the new password when changing the password to open the Tools window. (The name can contain up to 26 single-byte alphanumeric characters.)
2	Confirm	Enter the same password as you entered in New Password. If the passwords are not the same, an error is displayed.
3	Send	Click this button to confirm the changes made to the Admin Password.

FAQS:

I would like to remotely access the projector via the Internet. What is the best setting for the browser?

To have the best setting for the browser, please follow the below steps:

- 1 Open **Control Panel → Internet Options → General tab → Temporary Internet Files → Settings** → Select **Every visit to the pages**.
 - 2 Some firewall or anti-virus may block the HTTP application. If possible, turn off the firewall or anti-virus.
-

I would like to remotely access the projector via Internet. What socket port number should I open for it in the firewall?

The following are the TCP/IP socket ports which the projector uses.

UDP/TCP	Port Number	Description
TCP	80	Web configuration (HTTP)
UDP/TCP	25	SMTP: used for email routing between mail servers
UDP/TCP	161	SNMP: Simple Network Management Protocol
UDP	9131	AMX: used for AMX discovery

Why am I unable to access the projector via the Internet?

- 1 Check whether your computer/laptop is connected to the Internet.
- 2 Check with your MIS or network administrator whether your computer/laptop is in the same subnet.

Why am I unable to access the SMTP server?

- 1** Check with your MIS or network administrator whether the SMTP server function is open for the projector and the IP assigned to the projector is allowed to access the SMTP server. The projector's SMTP socket port number is 25, this cannot be changed.
- 2** Check if the outgoing SMTP server, user name, and password are set correctly.
- 3** Some SMTP servers will check whether the mail address of "From" correlates with the "User name" and "Password". For example, you use test@dell.com as the mail address in "From". You should also use test@dell.com account information for the User name and the password to log in the SMTP server.

Why am I unable to receive the test alert email even though the projector already indicates the test mail is already sent?

It could be because the SMTP server recognized the alert mail as a spam mail or because of the SMTP server restriction. Check with your MIS or network administrator for the SMTP server's setting.

Firewall Configuration and FAQ

Q: Why can't I access the Web Management Page?

A: Your computer's firewall configuration may prevent you from accessing the Web Management Web Page. Please refer to the following configuration settings:

Firewall Protection	Configuration
McAfee Security Center	<ol style="list-style-type: none">1 Launch McAfee Security Center (Start > All Programs > McAfee > McAfee Security Center).2 On the personal firewall plus tab, click View the Internet Applications List.3 Find and select Dell Projector from the list.4 Right-click on its Permissions column.5 Select Allow Full Access from the pop-up menu.
Norton AntiVirus	<ol style="list-style-type: none">1 Open Norton AntiVirus (Start > All Programs > Norton AntiVirus > Norton AntiVirus).2 Click Options menu, then select Norton AntiVirus.3 On the Status page, select Internet Worm Protection.4 Find and select Dell Projector from the list of programs.5 Right-click on its Internet Access column.6 Select Permit All from the pop-up menu.7 Click OK.
Sygate Personal Firewall	<ol style="list-style-type: none">1 Open Sygate Personal Firewall (Start > All Programs > Sygate > Sygate Personal Firewall).2 From the Running Applications list, find and right-click on Dell Projector.3 Select Allow from the pop-up menu.

Firewall Protection	Configuration
Windows Firewall	<ol style="list-style-type: none"> 1 Open Windows Firewall (Start > All Programs > Control Panel). Double-click on Windows Firewall. 2 On the General tab, uncheck Don't allow exceptions. 3 On the Exceptions tab, click the Add Program... button. 4 Find and select Dell Projector from the list of programs, then click OK. 5 Click OK to confirm exceptions settings.
Zone Alarm	<ol style="list-style-type: none"> 1 Open Zone Alarm Firewall (Start > All Programs > Zone Labs > Zone Labs Center). 2 On the Program Control page, find and select Dell Projector from the list. 3 Right-click on its Access-Trusted column. 4 Select Allow from the pop-up menu. 5 Right-click and select Allow for the Access-Internet, Server-Trusted, and Server-Internet columns.

Make Application Token

The Application Token lets you perform Plug and Show using a USB token.

- 1 From the application software, click  > **USB Dongle**
- 2 The following screen appears. Click **Next**.



- 3 Plug a flash drive into any of the USB ports on your computer. Select the drive from the list, then click **Next**.

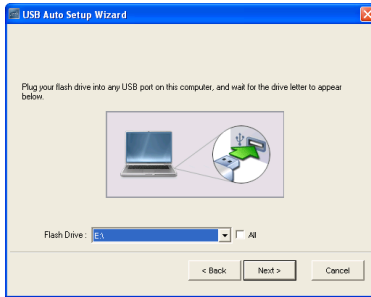

- 4 Click **Finish** to close the wizard.



4

Troubleshooting Your Projector



If you experience problems with your projector, see the following troubleshooting tips. If the problem persists, contact Dell (see Contacting Dell on page 147).



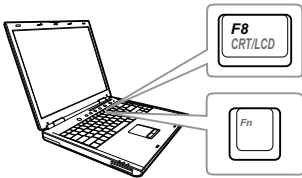

Problem

No image appears on the screen



Possible Solution

- Ensure that you have chosen the correct input source on the INPUT SOURCE menu.
 - Ensure the external graphics port is enabled. If you are using a Dell laptop computer, press   (Fn+F8). For other computers, see your respective documentation. If images are not displayed properly, please upgrade the video driver of your computer. For Dell computers, see support.dell.com.
 - Ensure that all the cables are securely connected. See "Connecting Your Projector" on page 9.
 - Ensure that the pins of the connectors are not bent or broken.
 - Ensure that the lamp is securely installed (see "Changing the Lamp" on page 139).
 - Use Test Pattern in the Projector Settings of the Advanced Settings menu. Ensure that the colors of the test pattern are correct.
-

Problem (continued)	Possible Solution (continued)
Partial, scrolling, or incorrectly displayed image	<ol style="list-style-type: none"> 1 Press the Auto Adjust button on the remote control. 2 If you are using a Dell laptop computer, set the resolution of the computer to WXGA (1280 x 800): <ol style="list-style-type: none"> a Right-click the unused portion of your Microsoft® Windows® desktop, click Properties, and then select Settings tab. b Verify that the setting is 1280 x 800 pixels for the external monitor port. c Press   (Fn+F8).
	<p>If you experience difficulty in changing resolutions, or if your monitor freezes, restart all the equipment and the projector.</p>
	<p>If you are not using a Dell laptop computer, see your documentation. If images are not displayed properly, please upgrade the video driver of your computer. For a Dell computer, see support.dell.com.</p>
The screen does not display your presentation	<p>If you are using a portable computer, press   (Fn+F8).</p>
Image is unstable or flickering	<p>Adjust the tracking in the OSD Display Settings of the Advanced Settings menu (in PC Mode only).</p>
Image has vertical flickering bar	<p>Adjust the frequency in the OSD Display Settings of the Advanced Settings menu (in PC Mode only).</p>

Problem (continued)	Possible Solution (continued)
Image color is incorrect	<ul style="list-style-type: none"> • If the display receives the wrong signal output from the graphics card, please set the signal type to RGB in the OSD Image Settings of the Advanced Settings tab. • Use Test Pattern in the Projector Settings of the Advanced Settings menu. Ensure that the colors of the test pattern are correct.
Image is out of focus	<ol style="list-style-type: none"> 1 Adjust the focus ring on the projector lens. 2 Ensure that the projection screen is within the required distance from the projector 1.96 ft [0.597 m] to 2.4 ft [0.731 m].
The image is stretched when displaying a 16:9 DVD	<p>The projector automatically detects the input signal format. It will maintain the aspect ratio of the projected image according to input signal format with an Original setting.</p> <p>If the image is still stretched, adjust the aspect ratio in the Display Settings of the Advanced Settings menu in the OSD.</p>
Image is reversed	Select Projector Settings of the Advanced Settings from the OSD and adjust the projector mode.
Lamp is burned out or makes a popping sound	When the lamp reaches its end of life, it may burn out and may make a loud popping sound. If this occurs, the projector does not turn back on. To replace the lamp, see "Changing the Lamp" on page 139.
LAMP light is solid amber	If the LAMP light is solid amber, replace the lamp.

Problem (continued)	Possible Solution (continued)
LAMP light is blinking amber	<p>If the LAMP light is blinking amber, the lamp module connection may be disrupted. Please check the lamp module and ensure that it is properly installed.</p> <p>If the LAMP lights and the Power light are blinking amber, the lamp driver has failed and the projector will automatically shut down.</p> <p>If the LAMP and TEMP lights are blinking amber and the Power light is solid blue, the color wheel has failed and the projector will automatically shut down.</p> <p>To clear the protection mode, press and hold the POWER button for 10 seconds.</p>
TEMP light is solid amber	<p>The projector has overheated. The display automatically shuts down. Turn the display on again after the projector cools down. If the problem persists, contact Dell.</p>
TEMP light is blinking amber	<p>If the projector fan fails, the projector will automatically shut down. Try to clear the projector mode by pressing and holding the Power button for 10 seconds. Please wait for about 5 minutes and try to power up again. If the problem persists, contact Dell.</p>
The remote control is not operating smoothly or works only within a limited range	<p>The battery may be low. If so, replace with two new AAA batteries.</p>

Problem (continued)

DoUSB not displaying

Possible Solution (continued)

- Windows

Display over USB Should run automatically. To manually run USB display, go to My Computer and run "USB_Display.exe".

- MAC

a Go to CDROM: USB_DISPLAY and run "MAC_USB_Display.pkg".

b Follow the on-screen instruction to complete installed.

c Reboot system, and then re-connect USB cable to the computer and the projector.



NOTE: You may require administrator level access to install the driver. Contact your network administrator for support.

IR Pen location offset

- 1** Ensure the output resolutions of the projector and computer are 1280x800.
 - 2** Select "second screen only" on the computer.
-

Guiding Signals

Projector Status	Description	Control Buttons		Indicator	
		Power	TEMP (Amber)	LAMP (Amber)	
Standby mode	Projector in Standby mode. Ready to power on.	White Flashing	OFF	OFF	OFF
Warming up mode	Projector takes some time to warm up and power on.	White	OFF	OFF	OFF
Lamp on	Projector in Normal mode, ready to display an image.  Note: The OSD menu is not accessed.	White	OFF	OFF	OFF
Cooling mode	Projector is cooling to shutdown.	White	OFF	OFF	OFF
Projector overheated	Air vents might be blocked or ambient temperature may be above 35 °C. The projector automatically shuts down. Ensure that the air vents are not blocked and that the ambient temperature is within operational range. If the problem persists, contact Dell.	OFF	AMBER	OFF	OFF
Lamp driver overheated	The lamp driver is overheated. The air vents may be blocked. The projector automatically shuts down. Turn the display on again after the projector cools down. If the problem persists, contact Dell.	AMBER	AMBER	OFF	OFF
Fan breakdown	One of the fans has failed. The projector automatically shuts down. If the problem persists, contact Dell.	OFF	AMBER Flashing	OFF	OFF
Lamp driver breakdown	The lamp driver has failed. The projector automatically shuts down. Unplug the power cord after three minutes and then turn the display on again. If this problem persists, contact Dell.	AMBER Flashing	OFF	AMBER Flashing	AMBER Flashing
Color Wheel breakdown	Color wheel cannot start. The projector has failed and the projector automatically shuts down. Unplug the power cord after three minutes and then turn on the projector. If this problem persists, contact Dell.	White	AMBER Flashing	AMBER Flashing	AMBER Flashing
Lamp failure	Lamp is defective. Replace the lamp.	OFF	OFF	AMBER	AMBER
Fault - DC supply (+12V)	Power supply has been interrupted. The projector automatically shuts down. Unplug the power cord after three minutes and then turn on the projector. If this problem persists, contact Dell.	AMBER Flashing	AMBER	AMBER	AMBER
Lamp module connection failed	Lamp module connection may be disrupted. Check the lamp module and ensure that it is properly installed. If the problem persists, contact Dell.	OFF	OFF	AMBER Flashing	AMBER Flashing

Changing the Lamp

⚠ CAUTION: Before you begin any of the procedures in this section, follow the Safety Instructions as described on page 8.

Replace the lamp when the message "**Lamp is approaching the end of its useful life in the operation. Replacement suggested!** www.dell.com/lamps" appears on the screen. If this problem persists after replacing the lamp, contact Dell. For more information, see "Contacting Dell" on page 147.

⚠ CAUTION: Use an original lamp to ensure safe and optimal working condition of your projector.

⚠ CAUTION: The lamp becomes very hot when in use. Do not attempt to replace the lamp until the projector has been allowed to cool down for at least 30 minutes.

⚠ CAUTION: Do not touch the bulb or the lamp glass at any time. Projector lamps are very fragile and may shatter if touched. The shattered glass pieces are sharp and can cause injury.

⚠ CAUTION: If the lamp shatters, remove all broken pieces from the projector and dispose or recycle according to state, local, or federal law. For more information see www.dell.com/hg.

- 1 Turn off the projector and disconnect the power cord.
- 2 Let the projector cool for at least 30 minutes.
- 3 Loosen the two screws that secure the lamp cover, and remove the cover.
- 4 Loosen the two screws that secure the lamp.
- 5 Pull the lamp up by its metal handle.

🔧 NOTE: Dell may require lamps replaced under warranty to be returned to Dell. Otherwise, contact your local waste disposal agency for the address of the nearest deposit site.

- 6 Replace with the new lamp.
- 7 Tighten the two screws that secure the lamp.
- 8 Replace the lamp cover and tighten the two screws.

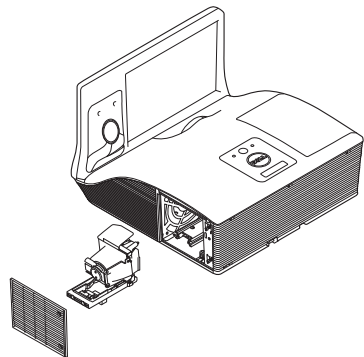

9 Reset the lamp usage time by selecting "Yes" for **Lamp Reset** in the OSD **Power Settings** of the **Advanced Settings** menu (see Power Settings of the Advanced Setting menu on page 52). When a new lamp module has been changed, the projector will automatically detect and reset the lamp hours.



CAUTION: Lamp Disposal (for the US only)

 **LAMP(S) INSIDE THIS PRODUCT CONTAIN MERCURY AND MUST BE RECYCLED OR DISPOSED OF ACCORDING TO LOCAL, STATE, OR FEDERAL LAWS. FOR MORE INFORMATION, GO TO WWW.DELL.COM/HG OR CONTACT THE ELECTRONIC INDUSTRIES ALLIANCE AT WWW.EIAE.ORG. FOR LAMP-SPECIFIC DISPOSAL INFORMATION, CHECK WWW.LAMPRECYCLE.ORG.**

5

Specifications

Light Valve	0.65" WXGA-800 S450 DMD, DarkChip3™
Brightness	3100 ANSI Lumens (Max.)
Contrast Ratio	Native: 2200:1 Typical High Contrast Ratio Mode: 8000:1 Typical
Uniformity	85% Typical (Japan Standard - JBMA)
Number of Pixels	1280 x 800 (WXGA)
Aspect Ratio	16:10
Internal Flash	2 GB Memory (Max.)
Displayable Color	1.07 billion colors
Color Wheel Speed	2 X 1 X for 3D Display
Projection Lens	F-Stop: F/ 2.6 Effective Focal length=654 mm \pm 10 mm @ 87.2 screen size Fixed lens, digital zoom only Throw ratio =0.35 wide and tele Offset Ratio: 125% \pm 5%
Projection Screen Size	70 ~ 100 inches (diagonal)
Projection Distance	1.7 ~ 2.49 ft (0.517 ~ 0.759 m \pm 0.01 m)
Video Compatibility	Composite Video: NTSC: M (3.58 MHz), 4.43 MHz PAL: B, D, G, H, I, M, N, 60 SECAM: B, D, G, K, K1, L Component Video input via VGA: 1080i, 720p, 576i/p, 480i/p HDMI input: 1080p, 720p, 576i/p, 480i/p
Power Supply	Universal AC 100-240 V 50-60 Hz with PFC input

Power Consumption	Normal mode: 345 W \pm 10% @ 110 Vac (Network On) Eco mode: 285 W \pm 10% @ 110 Vac (Network On) Standby mode: < 0.5 W Networked standby: < 9.6W
Audio	2 speaker x 10 watt RMS
Noise Level	Normal mode: 36 dB(A) Eco mode: 32 dB(A)
Projector Weight	16.76 lbs (7.6 kg)
IR Pen Weight	55.2 g (with batteries)
Dimensions (W x H x D)	14.1 x 9.1 x 14.4 inches (357 x 231 x 367 mm)

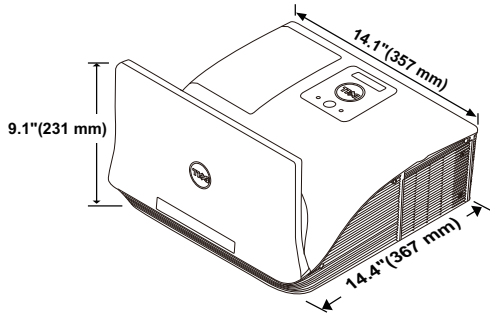

IR Pen Dimensions (D x Φ) 6.39 x 0.71 (162.2 x 18 mm)

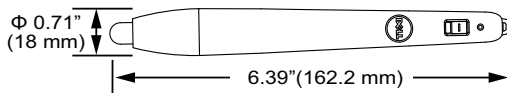

Environmental	<p>Operating temperature: 5 °C - 40 °C (41 °F-104 °F) Humidity: 80% maximum</p> <p>Storage temperature: 0 °C to 60 °C (32 °F to 140 °F) Humidity: 90% maximum</p> <p>Shipping temperature: -20 °C to 60 °C (-4 °F to 140 °F) Humidity: 90% maximum</p>
I/O Connectors	<p>Power: One AC power socket (3-pin - C14 inlet)</p> <p>VGA input: Two 15-pin D-sub connectors (Blue), VGA-A and VGA-B, for analog RGB/Component input signals.</p> <p>VGA output: One 15-pin D-sub connector (Black) for VGA-A loop through.</p> <p>Composite Video input: One Yellow RCA jack for CVBS signal.</p> <p>HDMI input: Two HDMI connector for supporting HDMI 1.4a. HDCP compliant/one with MHL.</p> <p>Analog Audio input: Two 3.5 mm stereo mini phone jack (Blue) and one pair of RCA connector (Red/White).</p> <p>Variable audio output: One 3.5 mm stereo mini phone jack (Green).</p> <p>USB (type B) port: One mini USB slave for remote support and firmware upgrade.</p> <p>RS232 port: One 9-pin D-sub for RS232 communication.</p> <p>USB (type A) port: One USB connector for multimedia playback (Video/Music/Photo/Office Viewer).</p> <p>USB (type B) port: One USB connector for supporting USB display and USB memory storage access (internal memory).</p>

Microphone	RJ45 port: One RJ45 connector for control of projector through network and LAN display. One 3.5 mm stereo mini phone jack (Pink).
Wireless	Wireless Standard: IEEE 802.11 a/b/g/n (2T2R) OS environment: Windows 8/7/Vista/XP/2000, MAC OS X Support: Presentation slides and projector control. Allow connection up to 30 users at the same time. 4-to-1 split screen. Allows four presentation slides to be projected on screen. Conference Control mode. Supports Audio Projection (driver installation may be required. Download from dell.com/support). Supports MobiShow and WiFi-Doc projection.
Lamp	OSRAM 280 W user-replaceable lamp
Lamp life	Normal mode: Up to 3000 hours Eco mode: Up to 4000 hours Dynamic eco cycle mode: Up to 5000 hours



NOTE: The lamp life rating for any projector is a measure of brightness degradation only, and is not a specification for the time it takes a lamp to fail and cease light output. Lamp life is defined as the time it takes for more than 50 percent of a lamp sample population to have brightness decrease by approximately 50 percent of the rated lumens for the specified lamp. The lamp life rating is not guaranteed in any way. The actual operating life span of a projector lamp will vary according to operating conditions and usage patterns. Usage of a projector in stressful conditions which may include dusty environments, under high temperatures, many hours per day, and abrupt powering-off will most likely result in a lamp's shortened operating life span or possible lamp failure.

RS232 Pin Assignment

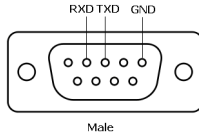

RS232 Protocol

- Communication Settings

Connection settings	Value
Baud Rate	19,200
Data Bits	8
Parity	None
Stop Bits	1

- Command types
To pop up the OSD menu and adjust the settings.
- Control command Syntax (From PC to Projector)
[H][AC][SoP][CRC][ID][SoM][COMMAND]
- Example: Power ON Command (Send low byte firstly)
--> 0xBE, 0xEF, 0x10, 0x05, 0x00, 0xC6, 0xFF, 0x11, 0x11, 0x01, 0x00, 0x01
- Control Commands List
To view the latest RS232 code, go to the Dell Support site at support.dell.com.
To view the latest SNMP commands and list, go to the Dell Support site at support.dell.com.

Compatibility Modes (Analog/Digital)

Resolution	Refresh Rate (Hz)	Hsync Frequency (KHz)	Pixel Clock (MHz)
640 x 350	70.087	31.469	25.175
640 x 480	59.940	31.469	25.175
720 x 480 p60	59.940	31.469	27.000
720 x 576 p50	50.000	31.250	27.000
720 x 400	70.087	31.469	28.322
640 x 480	75.000	37.500	31.500
640 x 480	85.008	43.269	36.000
800 x 600	60.317	37.879	40.000
800 x 600	75.000	46.875	49.500
800 x 600	85.061	53.674	56.250
1024 x 768	60.004	48.363	65.000
1280 x 720 p50	50.000	37.500	74.250
1280 x 720 p60	60.000	45.000	74.250
1920 x 1080 i50	50.000	28.125	74.250
1920 x 1080 i60	60.000	33.750	74.250
1280 x 720	59.855	44.772	74.500
1024 x 768	75.029	60.023	78.750
1280 x 800	59.810	49.702	83.500
1366 x 768	59.790	47.712	85.500
1360 x 768	60.015	47.712	85.500
1024 x 768	84.997	68.677	94.500
1440 x 900	59.887	55.935	106.500
1280 x 1024	60.020	63.981	108.000
1400 x 1050	59.978	65.317	121.750
1280 x 800	84.880	71.554	122.500
1280 x 1024	75.025	79.976	135.000
1440 x 900	74.984	70.635	136.750
1680 x 1050	59.954	65.290	146.250
1280 x 960	85.002	85.938	148.500
1920 x 1080	60.000	67.500	148.500
1024 x 768	119.989	97.551	115.500

6

Contacting Dell

For customers in the United States, call 800-WWW-DELL (800-999-3355).



NOTE: If you do not have an active Internet connection, you can find contact information on your purchase invoice, packing slip, bill, or Dell product catalog.

Dell provides several online and telephone-based support and service options. Availability varies by country and product, and some services may not be available in your area. To contact Dell for sales, technical support, or customer service issues:

- 1 Visit go to www.dell.com/contactDell.
- 2 Select your region on the interactive map.
- 3 Select a Segment for Contact.
- 4 Select the appropriate service or support link based on your need.

Contacting Crestron

Crestron provides phone based and online technical support options. Availability varies by country, but an e-mail to getroomview@crestron.com can be directed appropriately for users in any country.

Technical Support

In the US and Canada

Phone: 877-516-5394

Email: roomviewsupport@crestron.com

Outside the US and Canada

Phone: +1 201-367-1037

Email: roomviewsupport@crestron.com

7

Appendix: Glossary

ANSI Lumens — A standard for measuring the brightness. It is calculated by dividing a square meter image into nine equal rectangles, measuring the lux (or brightness) reading at the center of each rectangle, and averaging these nine points.

Aspect Ratio — The most popular aspect ratio is 4:3 (4 by 3). Early television and computer video formats are in a 4:3 aspect ratio, which means that the width of the image is 4/3 times the height.

Brightness — The amount of light emitted from a display or projection display or projection device. The brightness of projector is measured by ANSI lumens.

Color Temperature — The color appearance of white light. Low color temperature implies warmer (more yellow/red) light while high color temperature implies a colder (more blue) light. The standard unit for color temperature is Kelvin (K).

Component Video — A method of delivering quality video in a format that consists of the luminance signal and two separate chrominance signals and are defined as Y'Pb'Pr' for analog component and Y'Cb'Cr' for digital component. Component video is available on DVD players.

Composite Video — A video signal that combines the luma (brightness), chroma (color), burst (color reference), and sync (horizontal and vertical synchronizing signals) into a signal waveform carried on a single wire pair. There are three kinds of formats, namely, NTSC, PAL, and SECAM.

Compressed Resolution — If the input images are of higher resolution than the native resolution of the projector, the resulting image will be scaled to fit the native resolution of the projector. The nature of compression in a digital device means that some image content is lost.

Contrast Ratio — Range of light and dark values in a picture, or the ratio between their maximum and minimum values. There are two methods used by the projection industry to measure the ratio:

- 1 Full On/Off — measures the ratio of the light output of an all white image (full on) and the light output of an all black (full off) image.
- 2 ANSI — measures a pattern of 16 alternating black and white rectangles. The average light output from the white rectangles is divided by the

average light output of the black rectangles to determine the ANSI contrast ratio.

Full On/Off contrast is always a larger number than ANSI contrast for the same projector.

dB — decibel — A unit used to express relative difference in power or intensity, usually between two acoustic or electric signals, equal to ten times the common logarithm of the ratio of the two levels.

Diagonal Screen — A method of measuring the size of a screen or a projected image. It measures from one corner to the opposite corner. A 9 FT high, 12 FT wide, screen has a diagonal of 15 FT. This document assumes that the diagonal dimensions are for the traditional 4:3 ratio of a computer image as per the example above.

DHCP — Dynamic Host Configuration Protocol — A network protocol that enables a server to automatically assign a TCP/IP address to a device.

DLP[®] — Digital Light Processing[™] — Reflective display technology developed by Texas Instruments, using small manipulated mirrors. Light passing through a color filter is sent to the DLP mirrors which arrange the RGB colors into a picture projected onto screen, also known as DMD.

DMD — Digital Micro-Mirror Device — Each DMD consists of thousands of tilting, microscopic aluminum alloy mirrors mounted on a hidden yoke.

DNS — Domain Name System — An Internet service that translates domain names into IP addresses.

Focal Length — The distance from the surface of a lens to its focal point.

Frequency — It is the rate of repetition in cycles per seconds of electrical signals. Measured in Hz (Hertz).

HDCP — High-Bandwidth Digital-Content Protection — A specification developed by Intel[™] Corporation to protect digital entertainment across digital interface, such as DVI, HDMI.

HDMI — High-Definition Multimedia Interface — HDMI carries both uncompressed high definition video along with digital audio and device control data in a single connector.

Hz (Hertz) — Unit of frequency.

IEEE802.11 — A set of standards for wireless local area network (WLAN) communication. 802.11b/g/n uses the 2.4 GHz band.

Keystone Correction — Device that will correct an image of the distortion (usually a wide-top narrow-bottom effect) of a projected image caused by improper projector to screen angle.

Maximum Distance — The distance from a screen the projector can be to cast an image that is usable (bright enough) in a fully darkened room.

Maximum Image Size — The largest image a projector can throw in a darkened room. This is usually limited by focal range of the optics.

Minimum Distance — The closest position that a projector can focus an image onto a screen.

NTSC — National Television Standards Committee. North American standard for video and broadcasting, with a video format of 525 lines at 30 frames per second.

PAL — Phase Alternating Line. A European broadcast standard for video and broadcasting, with a video format of 625 lines at 25 frames per second.

Reverse Image — Feature that allows you to flip the image horizontally. When used in a normal forward projection environment text, graphics, etc. are backwards. Reverse image is used for rear projection.

RGB — Red, Green, Blue — typically used to describe a monitor that requires separate signals for each of the three colors.

SECAM — A French and international broadcast standard for video and broadcasting, closely related to PAL but with a different method of sending color information.

SSID — Service Set Identifiers — A name used to identify the particular wireless LAN to which a user wants to connect.

SVGA — Super Video Graphics Array — 800 x 600 pixels count.

SXGA — Super Extended Graphics Array, — 1280 x 1024 pixels count.

UXGA — Ultra Extended Graphics Array — 1600 x 1200 pixels count.

VGA — Video Graphics Array — 640 x 480 pixels count.

WEP — Wired Equivalent Privacy — This is a method for encrypting communication data. The encryption key is created and notified only to the communicating user, so the communication data cannot be decrypted by a third party.

XGA — Extended Video Graphics Array — 1024 x 768 pixels count.

WXGA — Wide Extended Graphics Array — 1280 x 800 pixels count.

Index

A

- Adjusting the Projector Focus 26
 - Focus ring 26

C

- Changing the Lamp 139
- Connecting the Projector
 - Audio cable 22
 - Composite Video cable 19
 - Connecting a Computer with a RS232 cable 13, 14, 15, 16
 - Connecting with a Component Cable 20, 22, 23
 - Connecting with a Composite Cable 19
 - Connecting with an HDMI Cable 21
 - HDMI cable 15, 21, 23, 24
 - L/R audio cable 19
 - MHL cable 16
 - Power cord 11, 12, 13, 14, 15, 16, 19, 20, 21, 22, 23, 24
 - RS232 cable 13
 - To Computer 11
 - USB to USB cable 11
 - USB-A to USB-B cable 14
 - VGA to VGA cable 11, 12
 - VGA to YPbPr cable 20

Connection Ports

- Audio left-channel input connector 9
- Audio output connector 9
- Audio right-channel input connector 9
- Audio-A input connector 9
- Audio-B input connector 9
- Composite Video connector 9
- HDMI-A connector for support MHL feature 9
- HDMI-B connector 9
- Microphone connector 9
- Mini USB (Mini Type B) 9
- Power cord connector 9
- RJ-45 connector 9
- RS232 connector 9
- USB Type A connector for USB Viewer 9
- USB Type B connector (DoUSB) for USB Display 9
- VGA output (monitor loop through) connector 9
- VGA-A input (D-sub) connector 9
- VGA-B input (D-sub) connector 9
- Contact Dell 5, 136, 139

D

Dell
 contacting 147, 149

I

Interactive Pen
 Battery 7
 Pen tip 7
 Power indicator 7
 Power switch 7
 Wrist strap holder 7

M

Main Unit 6
 10 W speaker 6
 Camera 6
 Focus ring 6
 IR receivers 6
 Lamp cover 6
 Lamp LED 6
 Lens 6
 Power button 6
 Temp LED 6

O

On-Screen Display 36
 ADVANCED SETTINGS 41
 AUDIO INPUT 40
 AUTO ADJUST 38
 BRIGHTNESS/CONTRAST 39
 HELP 54
 INPUT SOURCE 36
 INPUT SOURCE MULTIPLE

 DISPLAY 37
 LANGUAGE 54
 Main Menu 36
 VIDEO MODE 39
 VOLUME 40

P

phone numbers 147
Powering On/Off the Projector
 Powering Off the Projector 25
 Powering On the Projector 25

R

Remote Control 29

S

Specifications
 Audio 142
 Brightness 141
 Color Wheel Speed 141
 Contrast Ratio 141
 Dimensions 142
 Displayable Color 141
 Environmental 143
 I/O Connectors 143
 Light Valve 141
 Noise Level 142
 Number of Pixels 141
 Power Consumption 142
 Power Supply 141
 Projection Distance 141
 Projection Lens 141
 Projection Screen Size 141

- RS232 Protocol 145
- Uniformity 141
- Video Compatibility 141
- Weight 142

support

- contacting Dell 147, 149

T

telephone numbers 147

Troubleshooting 133

- Contact Dell 133